

FUTURE INSIDE



SHARED VALUE

12 Our Role **14** CEO Interview
16 Locations & Business Units
17 Results **18** EHS **19** Governance

BUSINESS VALUE

24 Business Highlights **26** Automotive
28 Aerospace **30** Packaging **32** Defense
33 Transportation **34** Industry

SUSTAINABLE VALUE

36 Sustainability Targets **37** UN SDGs
38 Materiality Assessment **40** Sustainability Highlights
42 Recycling Rates **43** Customer Satisfaction
44 Safety Records **45** People **46** Communities
47 Landfill Waste **48** Energy Efficiency
49 Aluminium Stewardship Initiative
50 Sustainable Purchasing
51 Greenhouse Gas Emissions

PERFORMANCE

53 Financial Statements
57 Sustainability Performance **65** GRI

Our role is to create value throughout the life cycle of aluminium. We are committed to improving the overall footprint of aluminium's life cycle and to creating value for customers, employees, suppliers, and society.

2

**CASTING, ROLLING,
AND EXTRUSION**

We work hard to mitigate the potential impact of our operations

3

**MANUFACTURING
AND PRODUCT DESIGN**

Our R&D and production teams work with our clients to leverage aluminium's inherent advantages, including lightness, flexibility, durability, and recyclability

LIFE CYCLE

1

**EXTRACTING, REFINING,
SMELTING**

With our suppliers, we have developed our own responsible purchasing policy

4

PRODUCT USE

For end users, we provide a large range of applications that enhance products and improve lifestyles

OF ALUMINIUM

6

RECYCLING

We recycle both process and end-of-life scrap

5

COLLECTING AND SORTING

With our clients, we have rigorous processes in place to collect and sort production scrap to retain its value

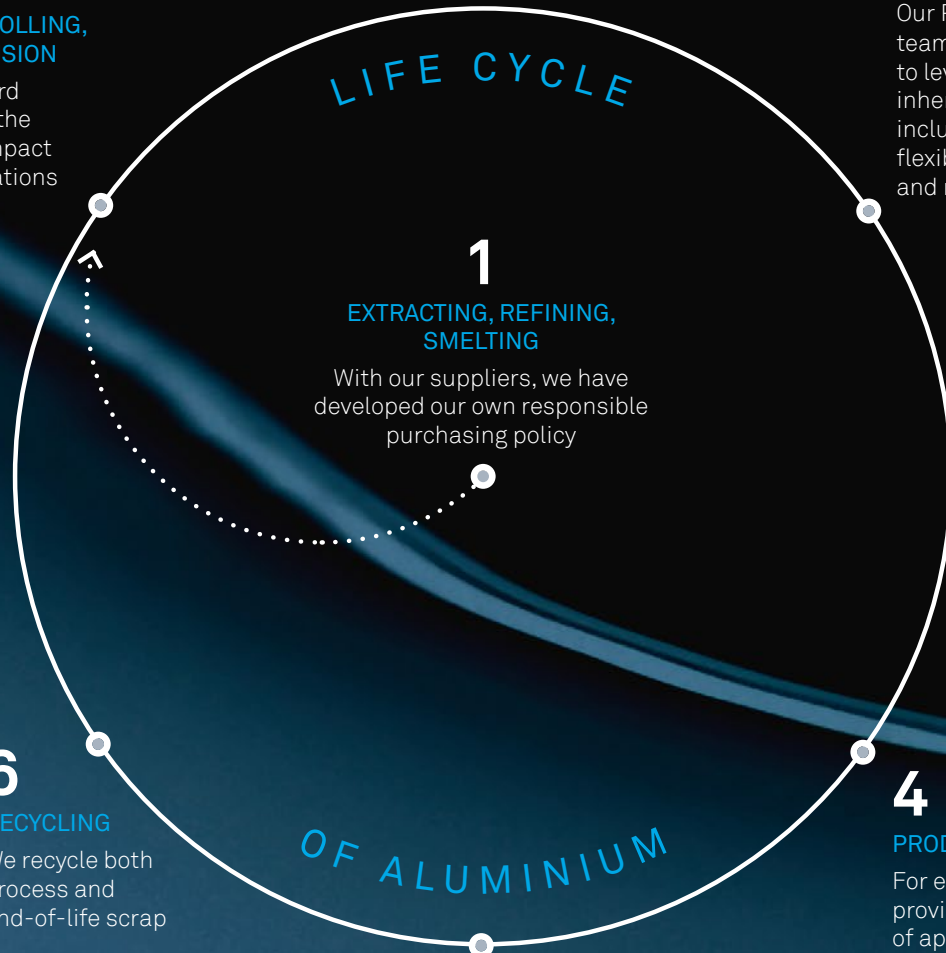



Inside Aluminium

100%

Aluminium is 100% recyclable with no deterioration in quality

75%

of the aluminium produced since its discovery is still in use today

5%

Recycling aluminium requires only about 5% of the energy needed to produce it from bauxite

Aluminium is valuable at every stage of its life cycle, from production to end of use. It can be endlessly recycled and keeps its material properties. Using recycled aluminium reduces the need for primary aluminium and therefore minimizes waste, avoids resource depletion, and lowers greenhouse gas emissions across a product's life cycle.

Constellium is an industry leader in the sustainable production and recycling of aluminium products. We embrace sustainability and work with our suppliers and partners to improve the footprint of the aluminium life cycle throughout the value chain.

Green in the Hood

-37%

Over the life cycle of a car, a hood produced with Constellium aluminium generates 37% less greenhouse gas emissions than a steel hood*

40%

A hood produced with Constellium aluminium is 40% lighter than a steel hood

90%

of aluminium contained in a scrapped vehicle is recycled

Aluminium is the material of choice to address one of the key challenges of the automotive industry, lightweighting. Our solutions help global automotive manufacturers to produce lighter, safer, and more fuel-efficient vehicles, as well as electric vehicles with greater range. Material lightweighting reduces CO₂ emissions over the life cycle of the car, ensuring a more sustainable future for the industry.

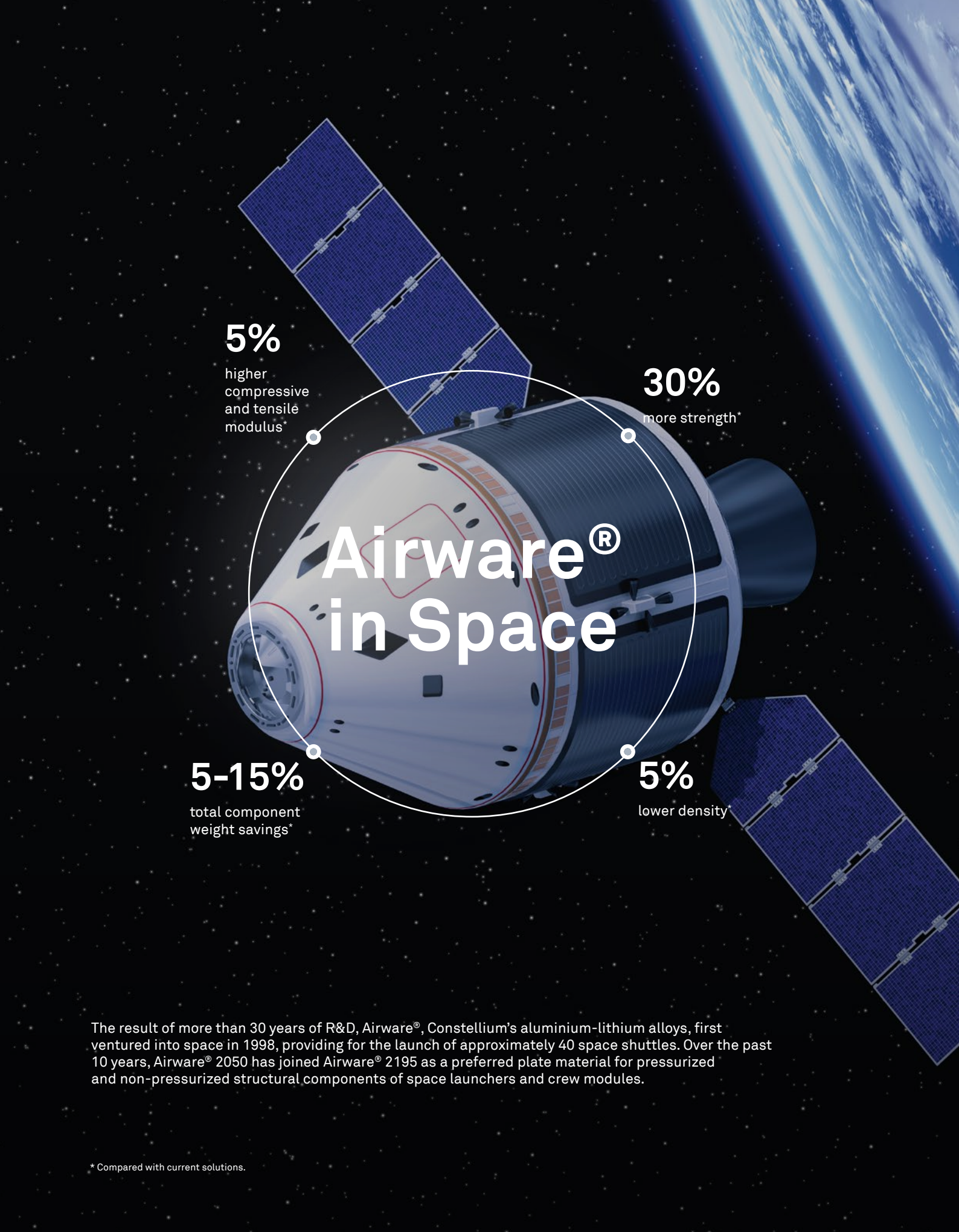

5%

higher
compressive
and tensile
modulus*

30%

more strength*

Airware® in Space

5-15%

total component
weight savings*

5%

lower density*

The result of more than 30 years of R&D, Airware®, Constellium's aluminium-lithium alloys, first ventured into space in 1998, providing for the launch of approximately 40 space shuttles. Over the past 10 years, Airware® 2050 has joined Airware® 2195 as a preferred plate material for pressurized and non-pressurized structural components of space launchers and crew modules.

* Compared with current solutions.



Lighter Safer Greener

7 million

We supply 7 million Crash Management Systems a year

560 million

metric tons of CO₂ saved in emissions over a vehicle's lifetime*

5 kg

saved on each aluminium Crash Management System compared with a traditional system

For automakers, enhancing the safety of drivers, passengers, and pedestrians is a top priority. Constellium's superior design capabilities mean we can offer the most innovative Crash Management Systems (CMS) to our customers. Aluminium is the ideal material for CMS components due to its superior energy absorption and crash behavior. Thanks to our Constellium HSA6™ family of high-strength 6xxx alloys, we can reduce the system's weight by 15-30% compared with traditional aluminium solutions, and by over 50% compared with steel.

* Constellium estimate based on 10 g/km CO₂ saved for every 100 kg, and a useful life of 160,000 km per vehicle.

Up to 50%

savings in
manufacturing time

Up to 15 times

better flatness compared
with industry standards

Alplan™ Beyond Precision

Up to 90%

reduction in part rework
compared with a mill
finish plate

Up to 40%

reduction in materials
required vs. mill finish
plate

As we focus on offering sustainable growth solutions to our customers, Alplan™ Beyond Precision, the result of a long-standing proprietary process optimized over the last 20 years, is an unrivaled solution for high performance aluminium plates. An integrated solution, Alplan™ allows for increased productivity and reduced production costs.

**20,000
people/hour**

A single high-speed rail line transports up to 20,000 people per hour

20x

High-speed rails have 20 times the capacity of highways

High Speed and On Track

76%

fewer carbon dioxide emissions by train, compared with air travel for the same distance

**300 km/h
(200 mph)**

Some high-speed rail services can reach speeds of over 300 km per hour

Economic development and environmental concerns are leading to a huge global expansion and modernization of rail networks and rolling stock. By using our lightweight solutions, rail vehicle manufacturers can increase passenger capacity and save energy, leading to significant CO₂ reductions.

Constellium is a market leader in rail solutions, covering the complete range of rolling stock material with our large extrusions product portfolio, for trams and subways, regional trains, and high-speed trains. Constellium's aluminium-steel co-extruded power rails also help guarantee electricity supply to underground and suburban train systems around the world.



More Sustainable Supplies

50+%

of our annual supplier spending has been through independent third-party sustainability assessment

83%

of evaluated suppliers' performances meet or surpass our standards

45%

of our suppliers have improved their sustainability performance since 2011

We must ensure that sustainability is practiced at every step of our business, including the supply chain. That's why Constellium seeks to work exclusively with suppliers who comply with applicable laws and adhere to sustainable practices in governance, the environment, and society.

Supplier assessment is not simply a perfunctory exercise for us. We see it as an opportunity to work together for continuous improvement, and believe it helps to build strong, long-term relationships with our suppliers.

Energy Efficient

10%

our 2020 target
for energy
efficiency
improvement
vs. 2015

4.7%

improvement in Constellium's
energy efficiency compared
with 2015 baseline

6 million

automotive Crash
Management Systems
can be produced using
270 GWh of energy
saved since 2015

Reducing our carbon footprint and the negative impact of our operations is high on our sustainability agenda. We saw significant improvement in all business units in 2018, and we continue to focus our efforts and resources on all potential energy-saving opportunities to reach our 2020 energy efficiency goal.

SHARED VALUE

Strong, versatile, and renewable, aluminium is an integral part of our daily lives. At Constellium, we are experts at turning it into value-added products and solutions. From beverage cans to electric vehicles to space shuttles, we are constantly innovating for a lighter, safer, and more sustainable tomorrow.

CREATING VALUE THROUGHOUT THE LIFE CYCLE OF ALUMINIUM

Aluminium is the world's third most abundant element and a vital material for the 21st century. Here, we explain the various stages of production and outline our role in the process.



Product design and manufacturing

Engineers and researchers from our world-class C-TEC Technology Center, our Plymouth hub, and our Brunel University Technology Center work closely with our customers to develop, produce, and deliver innovative and sustainable aluminium solutions that improve the world around us. We also offer product design capabilities, particularly for automotive component fabrication.

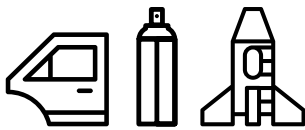

PRODUCT DESIGN AND MANUFACTURING

Product use

We have longstanding relationships with customers in diverse industries, primarily the aerospace, packaging, and automotive sectors. The products and solutions we provide improve strength, durability, lightness, and fuel consumption in a large range of applications.



PRODUCT USE



COLLECTING AND SORTING

Collecting and sorting

Aluminium recycling within the manufacturing process makes sense economically and environmentally. Efficient collection and sorting systems are critical for the effective recycling of end-of-life scrap. We have established stringent procedures at our facilities and offer similar services to customers, creating value by reducing costs and recycling more products.

INTERVIEW

Jean-Marc Germain, Chief Executive Officer



“We have a strong and balanced portfolio to support our attractive long-term growth plan.”

How did Constellium perform in 2018?

I'm proud to say that 2018 was another year of growth and improvement. Once again we saw double-digit Adjusted EBITDA growth, with each of our business units delivering record annual Adjusted EBITDA. In July, we completed the sale of the North Building at Sierre to Novelis, which contributed to our deleveraging. In December, we announced the acquisition of our partner's 49% stake in Bowling Green, giving us full access to the attractive North American Auto Body Sheet market.

As for EHS, we had positive results overall and a significant decrease in our recordable case rate, even beyond our target. Tragically, we experienced one fatality, at Neuf-Brisach. It was a terrible reminder of why safety must always be our number one priority.

Were your results impacted by trade issues and global tariffs?

It was indeed a very eventful year, marked by uncertainty in the global aluminium supply chain, largely as a result of the U.S. 232 tariffs on aluminium and temporary sanctions on Rusal. As a result of our pass-through model, the impact of these actions on our business has been limited. In addition, most of our production is made for consumption in the same geographic area (i.e. produced in North America for North America, or in Europe for Europe), which also helps mitigate the impact of tariffs. That said, the global trade environment is still unstable, and we will continue to monitor potential developments closely in 2019.

FINANCIAL GUIDANCE

2019 TARGETS		2022 TARGETS	
ADJUSTED EBITDA GROWTH	FREE CASH FLOW	ADJUSTED EBITDA	NET DEBT/ ADJUSTED EBITDA
8-10%	€50+ million	€700+ million	2.5x

Is the automotive market still a growth driver for you?

Yes, and we are confident that increased aluminium use is a secular trend for this market, due to the material's lightweighting properties and superior energy absorption. The electrification of vehicles has great potential for us, and we have good exposure in the growing markets for light trucks, SUVs, and luxury cars. We are well-positioned to take advantage of the automotive industry's shift to aluminium with the ramp-up of our two new 100 kt CALP lines in Neuf-Brisach and Bowling Green, as well as the expansion of our Automotive Structures business.

Our growth does not rely on the automotive market alone. Aerospace provides a steady stream of opportunities for growth and higher value-added products. Packaging is another strong, stable component of our portfolio. As recycling becomes a priority for our customers and society at large, we expect aluminium to stand out as a preferred material for beverages, since it can be recycled indefinitely. We have attractive growth opportunities in other niches, too. Overall, I believe we have a strong and balanced portfolio to support our long-term growth plan.

How are you doing on the execution of your strategy?

We are pleased with the progress we have made and will continue to execute our strategy in 2019. To ensure that the entire company is aligned with stakeholders' expectations, we have shared our strategy, mission, and values with our employees through a dedicated, company-wide initiative called MOMENTUM. After years of significant investments in our business, 2019 is also the year we targeted to generate positive free cash flow. We are confident of reaching this goal, thanks to robust growth, continuous operational improvement, and a strong focus on trade working capital.

What are your priorities in terms of sustainability?

They are clearly set out in our 2020 sustainability targets (see page 36). Safety remains number one; we are determined to further improve our record and prevent serious injuries.

We have made progress on most of our targets and will keep working towards them. As one of the founding members of the Aluminium Stewardship Initiative (ASI), we are working to obtain ASI certification for our biggest plant in Germany, and to have our packaging and automotive plant in Neuf-Brisach, France, certified as well. Meanwhile, we are doing our best to ensure that our suppliers

STRATEGY

- ▶ Focus on high-value products
- ▶ Grow customer connectivity
- ▶ Optimize asset utilization through portfolio management
- ▶ Harvest returns from past investments
- ▶ Strict cost control and continuous improvement
- ▶ Increase financial flexibility

comply with the ASI standard. Recycling remains another key focus, and we continue to promote end-of-life recycling.

What are your priorities for 2019?

From a safety standpoint, we always aim for zero accidents. We will continue to focus on our Serious Injury and Fatality (SIF) program, and on promoting behavioral changes.

Financially, we are committed to becoming free cash flow positive in 2019 and beyond, significantly reducing our debt and achieving our targets.

We remain committed to our sustainability goals, minimizing our ecological impact while maximizing the social and environmental benefits of our products. We empower our employees, providing them with career development opportunities and practicing shared values. These engagements are an important part of our efforts to make Constellium the most exciting company to work for in the aluminium industry.

I am very optimistic about our prospects for the future, and am looking forward to delivering another strong year in 2019.



United Nations
Global Compact

COMMITMENT TO THE UNITED NATIONS GLOBAL COMPACT

For the seventh consecutive year we support the Ten Principles of the **United Nations Global Compact (UNGC)** in the areas of human rights, labor, environment, and anti-corruption. In this report we communicate on our progress in the Sustainability Performance section on page 57.

A GLOBAL SECTOR LEADER

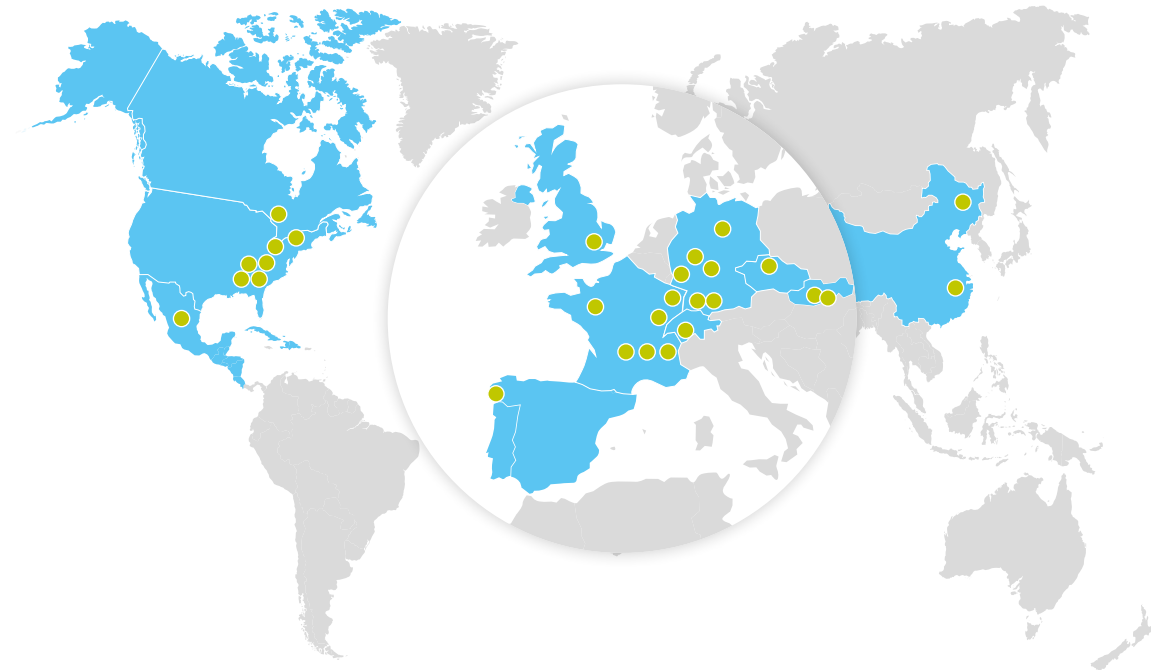

Packaging and Automotive Rolled Products

Provides aluminium sheets and coils for packaging applications (beverage and food cans, closures, foilstock, cosmetics), specialty products (functional surfaces and industry products), as well as automotive solutions, including Auto Body Sheet. In addition, the business unit recycles end-of-life products, such as used beverage cans.



ROLLED PRODUCTS



RECYCLING

Aerospace and Transportation

Provides technologically advanced aluminium alloys with wide applications across the global aerospace, transportation, industry, and defense sectors. The business unit offers a wide range of products including plates, sheets, and extrusions. Aerospace and Transportation also provides tailored solutions and value-added services to its customers, such as pre-machining and customer scrap recycling.



ROLLED PRODUCTS



PLATES



EXTRUDED PRODUCTS

Automotive Structures and Industry

Provides advanced solutions for the global automotive industry, including Crash Management Systems (CMS), structural components, battery enclosures, and other safety parts and extrusions. This business unit also manufactures a wide range of hard and soft alloy extrusions, as well as large profiles for road and rail transportation, energy, and other industrial applications.



EXTRUDED PRODUCTS



AUTOMOTIVE COMPONENTS

UNLOCKING VALUE

REVENUE

€5.7 BN

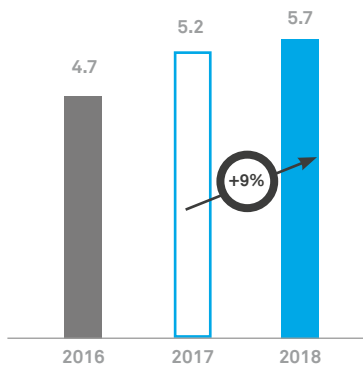

ADJUSTED EBITDA*

€498 M

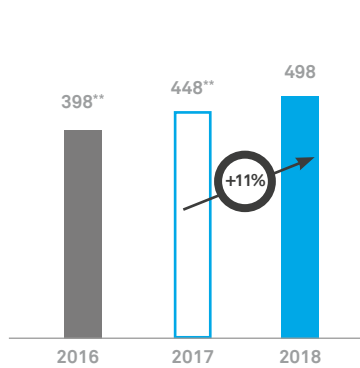

EMPLOYEES

~13,000

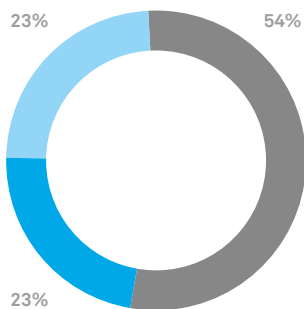

- PACKAGING AND AUTOMOTIVE ROLLED PRODUCTS
- AEROSPACE AND TRANSPORTATION
- AUTOMOTIVE STRUCTURES AND INDUSTRY

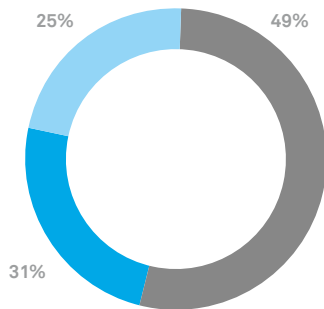

- PACKAGING AND AUTOMOTIVE ROLLED PRODUCTS
- AEROSPACE AND TRANSPORTATION
- AUTOMOTIVE STRUCTURES AND INDUSTRY

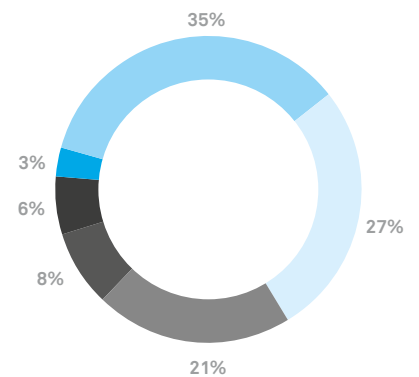

- FRANCE
- NORTH AMERICA
- GERMANY
- EASTERN EUROPE
- SWITZERLAND
- ASIA

* Adjusted EBITDA is a "Non-GAAP measure." For a reconciliation of this measure to "Net Income," see the 20-F.

** In 2018, we changed the presentation of our pension and other benefit expense. Comparative financial information for prior years has been reclassified accordingly to conform to the current year's presentation.

ENVIRONMENT, HEALTH AND SAFETY

Interview with **Jack Clark**, Senior Vice President,
Manufacturing Excellence and Chief Technical Officer



“Environment, Health and Safety (EHS) is not just a matter of policies and processes, but also of behavior and engagement – an overall culture of commitment to one another.”

What were Constellium’s greatest safety achievements in 2018?

The launch of our Serious Injury and Fatality (SIF) program was certainly a highlight. Through this program we were able to reduce the number of serious injuries from 14 in 2017 to 3 in 2018. Its major components include the formation of a plant-wide SIF team, engaging the workforce to identify risks on the shop floor, and addressing these risks. With a renewed emphasis on the importance of leadership and streamlining the EHS Management system, we were able to set an all-time low for our recordable rate. We continued our efforts to improve safety in our recycling and casting operations units, with good progress on our hands-free casting initiative. Our focus remains on promoting safe behavior for all.

Why such a focus on behavior?

While we made significant progress on our safety results, we cannot be proud as we tragically lost one of our colleagues in a workplace incident in Neuf-Brisach, France, in 2018. This fatality is a strong reminder that behavior is as critical as policies and procedures when it comes to safety, and that our Safety Golden Rules must be respected at all times. We lost one of our most experienced workers, who was trained in EHS requirements. It was and still is a shock for all of us.

How were Constellium’s environmental results in 2018?

Very encouraging. There were no major incidents in 2018, and our reporting improved significantly. Our 2019 priority will be to comply with upcoming environmental regulations in the European Union. We will also continue to focus on reducing energy consumption and reducing landfill waste to meet our 2020 sustainability goals.

How are you working to promote better health among your employees?

Our objective is to prevent work-related diseases and to promote employee health. Many of our sites are offering health programs including flu vaccinations, fitness classes, eye testing, and other benefits. Most of our locations also have an Employee Assistance Program to support our employees and their families with personal concerns ranging from significant life events to everyday challenges.

What will be your key priorities in 2019?

Our focus remains on safety and continuing to reduce recordable and serious injuries. We are focusing on peer-to-peer interaction, and specifically, how to get more employees to correct their co-workers’ unsafe actions. We will also keep working to ensure that Constellium is an environmentally responsible neighbor in the communities in which we operate.

GOVERNANCE

Director independence

We maintain a one-tier Board of Directors consisting of an Executive Director and Non-Executive Directors (each a “Director”). Under Dutch law, the Board of Directors is responsible for the policy-making and management of the Company. The Non-Executive Directors supervise and provide guidance to the Executive Director.

As a foreign private issuer under the Securities and Exchange Commission (SEC) rules, we are not required to have Independent Directors on our Board of Directors (but it is required that our Audit Committee consist of Independent Directors).

However, our Board of Directors has determined that, under current NYSE listing standards regarding independence (which we are not currently subject to), and taking into account any applicable committee standards, as of December 31, 2018, Messrs. Evans, Brandjes, Guillemot, Hartman, Maugis, Ormerod, and Paschke and Ms. Brooks, Ms. Walker, and Ms. Frachet are Independent Directors.

Board meetings in 2018

The Board of Directors held six meetings and reviewed a number of matters, including: committee reports; reports from the CEO (including environmental, health & safety, markets and competition) and from the CFO and the Group’s General Counsel; conversion and relocation of the Group’s corporate headquarters; review and approval of the 2017 Annual Accounts and Form 20-F filing with the SEC; approval of the agenda items for the Annual General Meeting 2018; approval of executive remuneration and remuneration policy for Non-Executive Directors; reports from business units; review of Company strategy and strategic opportunities; review of 2019 budget; finance reports; presentation on investor perception, and Board and Directors’ third-party evaluation results.

Our committees

Audit Committee

As of December 31, 2018, the Audit Committee held eight meetings and consisted of four Independent Directors:

- Werner P. Paschke (Chairman)
- Martha Brooks
- John Ormerod
- Lori A. Walker

Human Resources and Remuneration Committee

As of December 31, 2018, the Remuneration Committee held five meetings and consisted of four Directors:

- Peter F. Hartman (Chairman)
- Martha Brooks
- Richard B. Evans
- Guy Maugis

Nominating/Corporate Governance Committee

As of December 31, 2018, the Nominating/Corporate Governance Committee held five meetings and consisted of three Directors:

- Richard B. Evans (Chairman)
- Michiel Brandjes
- John Ormerod

Policies

Code of Conduct

Our worldwide Code of Employee and Business Conduct sets out the standard of behavior we expect from our employees. The Code governs the way Constellium acts in business, and how we expect our business partners, customers, and suppliers to behave. It was renewed in 2018, reinforcing the standard of anti-corruption and Human Rights and Labor Practices. It applies to all Constellium employees, subject to applicable local law. Compliance with the Code is essential to preserving and enhancing the Company’s reputation as a responsible corporate citizen and, ultimately, to maximizing shareholder value. For suppliers, we have developed a specific Code of Conduct.

Whistleblower policy

Our whistleblower policy fosters an environment where our employees can act without fear of retaliation and report wrongdoing or suspected wrongdoing, corruption, or irregularities in finance, accounting, or banking as concerns Constellium to a reporting official. To facilitate this reporting, we have established an external hotline in all the countries in which we have operations and in various languages.

Insider Trading policy

We have an Insider Trading policy which sets out the restrictions on trading in Constellium securities and the use of inside information.

BOARD OF DIRECTORS

The Board of Directors is collectively responsible for the management of the Company, the general conduct of the Company's business, and its corporate governance structure. The Non-Executive Directors supervise and provide guidance to the Executive Director, who is entrusted with the day-to-day management of the Company.

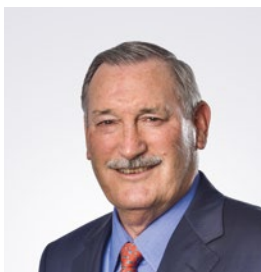

Richard B. Evans
Chairman

Chairman of our Board since December 2012 and a member of our Board of Directors since January 2011



Jean-Marc Germain
Executive Director

Executive Director of the Board of Directors since June 2016 and Chief Executive Officer since July 2016

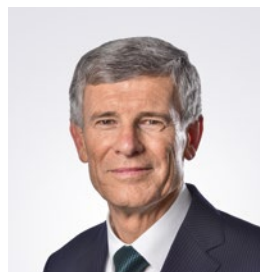

Michiel Brandjes
Non-Executive Director

Member of our Board of Directors since June 2014



Martha Brooks
Non-Executive Director

Member of our Board of Directors since June 2016



Stéphanie Frachet
Non-Executive Director

Member of our Board of Directors since May 2018



Philippe Guillemot
Non-Executive Director

Member of our Board of Directors since May 2013



Peter F. Hartman
Non-Executive Director

Member of our Board of Directors since June 2014



Guy Maugis
Non-Executive Director

Member of our Board of Directors since January 2011



John Ormerod
Non-Executive Director

Member of our Board of Directors since June 2014

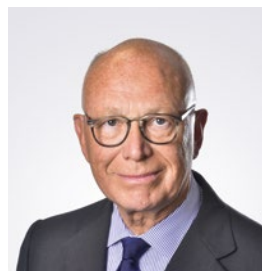

Werner P. Paschke
Non-Executive Director

Member of our Board of Directors since May 2013

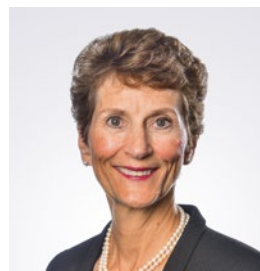

Lori A. Walker
Non-Executive Director

Member of our Board of Directors since June 2014

EXECUTIVE COMMITTEE

Our Executive Committee focuses on strategy, financial management, commercial developments, program execution, organizational evolution, and Group-wide policies. Together, they combine close to 200 years of experience in the aluminium industry.



Jean-Marc Germain
Chief Executive Officer



Peter R. Matt
Executive Vice President
and Chief Financial Officer



Peter Basten
President, Packaging and
Automotive Rolled Products
business unit



Nicolas Brun
Senior Vice President, Public
Affairs, Communications,
and Sustainability



Jack Clark
Senior Vice President,
Manufacturing Excellence
and Chief Technical Officer



Ingrid Joerg
President, Aerospace and
Transportation business unit



Ryan Jurkovic
Senior Vice President
and Chief Human Resources
Officer



Jeremy Leach
Senior Vice President
and Group General Counsel



Vittorio Rossetti
Vice President and Chief
Information Officer



Paul Warton
President, Automotive
Structures and Industry
business unit

SUSTAINABILITY COUNCIL

Making sustainability an integral part of everything we do

Founded in 2012, the Sustainability Council is the driving force helping Constellium to achieve our sustainability targets.

“We were very excited to host the Council at Ravenswood. We now better understand the Group’s sustainability agenda and policies. It’s also important to see how Ravenswood’s initiatives can contribute to achieving our targets.”

Buddy Stemple,
CEO Constellium Rolled Products Ravenswood



▲ Sustainability Council meeting at our Ravenswood plant in November 2018

The Sustainability Council is a formal body whose members are responsible for guiding Constellium towards our 2020 sustainability goals. The Council meets four times a year, including once with Constellium’s Executive Committee. In July 2018, it presented the Executive Committee with a progress report on our 2020 Sustainability Roadmap.

In 2018, the Sustainability Council spent time at two of our sites, Singen, Germany and Ravenswood, U.S. The Council shared information about our sustainability projects and progress with each plant’s management team, and also learned about the plants’ own actions on site.

Embedding sustainability throughout the company

Some of our sustainability targets are related to our manufacturing operations. That’s why our Manufacturing Council, chaired by our Senior Vice President of Manufacturing Excellence and Chief Technical Officer, and consisting of the presidents of our business units as well as senior managers of Strategy, Finance, and EHS, interacts regularly with the Sustainability Council. Together, they review and discuss specific issues related to our energy efficiency and landfill waste objectives.

In 2018, we introduced a face-to-face presentation and sustainability discussion as part of the onboarding program for new hires. During these sessions, we presented the company’s sustainability program and various initiatives, thereby engaging newcomers in helping us achieve our 2020 targets. It has become increasingly important for our sales and purchasing teams to be able to respond to customers’ requests and society’s expectations regarding sustainability, so we conducted customized training sessions in 2018. The sessions familiarized the teams with tools and policies to help them address sustainability challenges and requests.

BUSINESS VALUE

Our business is making the future lighter and brighter.

We create value throughout aluminium's life cycle, thanks to our ~13,000 employees, 25+ manufacturing sites, and state-of-the-art research centers. Our revolutionary products and top-notch services meet the most challenging requirements of our customers and society.

BUSINESS HIGHLIGHTS

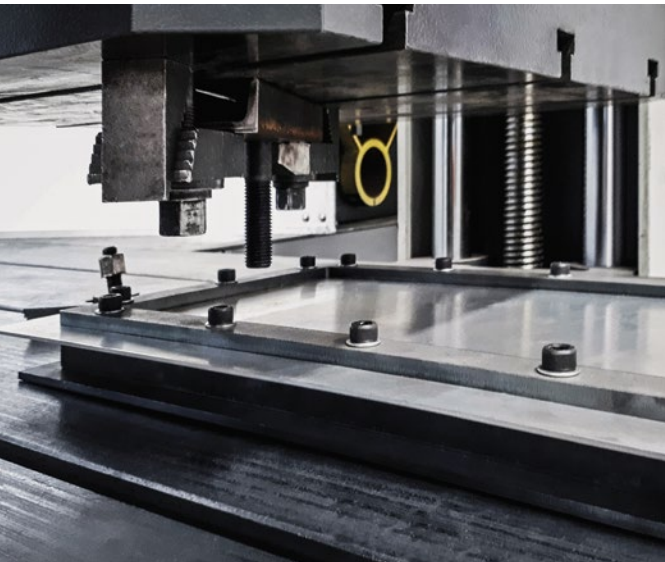

Tailor-made Tests

As Constellium advances technologies (materials, shapes, joining methods, etc.) for **the battery enclosures of electric vehicles**, we have also developed new testing equipment and methods where standards do not yet exist. One example is a test for intrusion on the bottom plate of a battery enclosure, which is susceptible to undercarriage impacts from debris in the road. Thanks to these new testing methods, which reduce development time and save on costs, we can design bottom plate systems that help **minimize intrusion risks** and **optimize the dimensions and weight of battery enclosure packages**.



Lighter Cans? No Sweat!

Moravia Cans, a Czech aerosol can producer, is using our Aeral™ aluminium solution for **Unilever's Dove** antiperspirant. Normally used for beverage cans, the breakthrough technology behind **Aeral™** allows

up to 30% weight savings while maintaining ductility and pressure resistance.



Hello, Düsseldorf!

Constellium exhibited its extensive range of advanced solutions at **Aluminium 2018**, the world's largest trade fair dedicated to aluminium and its applications, in October. With a booth built around the concept of **"Aluminium in the city,"** Constellium highlighted how its **innovative and sustainable** solutions contribute to modern cities – from building architecture to automobiles, planes, and packaging.

SEARCH ENGINES

Customers can now search for aluminium plates, coils, and sheets via our new product search tool. It is an online catalogue of products available in different markets, organized by criteria such as alloy family or thickness. The **Product Finder** boosts the visibility of our range and provides customers with a quick and easy way to find the information they need. www.constellium.com/product-finder

Architectural Aluminium

Laminium OAB® is Constellium's solution for best-in-class anodized aluminium architectural applications. Laminium OAB® was **developed by our R&D Center** in Voreppe, France, to comply with the highest standards in terms of appearance, color consistency between batches, formability, and long-term resistance. Laminium OAB® allows architects to create complex styles and designs with a unique aspect.



FACTORIES OF THE FUTURE

Constellium launched 10 pilot projects to study how **Industry 4.0** can revolutionize our factories, making them safer and more efficient. Digital technology helps us reduce energy consumption, optimize scrap use, and predict when a machine might fail. Collaborative robots can perform physically demanding or potentially dangerous tasks, while smart devices warn of risk. Our Digital@Constellium pilot program is due to be completed by late 2019.



Automotive in High Gear

Constellium continued to expand our longstanding partnership with many of our automotive customers. We're supplying Crash Management Systems, front rails, and Auto Body Sheet for the new **BMW X Series Sports Activity Vehicles**. For the new **Mercedes-Benz Front Wheel Drive Platform (A-Class, B-Class, CLA, GLA, GLB)**, we're providing front **Crash Management Systems** and other structural components. And we are the primary supplier of automotive body sheets for closures and inner parts of the new **Audi A6**.



Cruising Speed with Boeing

We signed a multi-year contract with our multi-decade partner **Boeing** to supply its commercial airplane programs with advanced aluminium rolled products, mostly from our plant in **Ravenswood, West Virginia**. The agreement confirms our position as a world leader in aluminium products and solutions for the aerospace industry.

BEST IN CLASS

Constellium's **University Technology Center (UTC)** at Brunel University, London, is adding **new research capabilities**. In addition to full scale casting and extrusion, the UTC now **prototypes and tests aluminium automotive components** such as Crash Management Systems, body structure components, and battery enclosures for electric and hybrid vehicles. This means we can help automakers further reduce their development phase and time-to-market.



Believing in Bowling Green

We strengthened our position as an aluminium supplier to automotive customers by deciding to acquire UACJ's 49% stake in our **Bowling Green, Kentucky**, auto body sheet joint venture. The decision gives us greater scale and control over **Auto Body Sheet** development in North America, an attractive and growing market.

AUTOMOTIVE

A unique partner for automakers

We do it all: material science, component prototyping and production, simulation and testing, product development.

Constellium is one of the few companies able to produce both flat rolled products and automotive structures that meet the quality and quantity required by car manufacturers.

An accelerating market

Automotive is expected to remain an attractive growth market for aluminium in Europe and North America, due to:

- Secular growth driven by lightweighting
- Greater adoption of aluminium Auto Body Sheet and structural components in luxury cars, light trucks, and SUVs
- Higher aluminium intensity per vehicle.

According to CRU, annual consumption of **Auto Body Sheet between 2018 and 2023 will grow 10% in Europe, 11% in North America, and 27% in China.** Strong growth is also expected for structural components and Crash Management Systems.



Innovating for safer roads



Engine rail

Protecting passengers and pedestrians

Beyond lightweighting, aluminium's superior energy absorption properties make it an excellent material for safety. We design rolled products and structural components to be lighter and safer.

- As part of our Auto Body Sheet offer, **Securalex®**, our portfolio of high-tech crash absorption alloys, fulfills the most demanding safety requirements. Securalex® HS can absorb as much energy as the most crash-resistant steel with 30% less weight. Highly formable Securalex® P6 is used for hood inners (for instance on the new Audi A6) to enhance pedestrian safety.
- As part of our structural components offer in addition to Crash Management Systems, in 2018 Constellium began producing **aluminium engine rails** for the new BMW X5 Sports Activity Vehicle. Part of the vehicle architecture, the rails help support engines and absorb energy in a high-speed collision. They are 5 kg lighter than the prior model's steel version and manufactured at our White, Georgia plant, honored as the "Innovator of the Year" at the 2018 Georgia Automotive Awards.

ELECTRIC VEHICLES DRIVING DEMAND



- ▶ Bloomberg NEF 2018 Electric Vehicle Outlook is expecting **sales of electric vehicles (EVs) to increase from a record 1.1 million worldwide in 2017 to 11 million in 2025 and then surge to up to 30 million in 2030, with China leading the transition.**
- ▶ According to Constellium's in-house studies, electric vehicles can have **3-5 times the aluminium rolled and extruded product weight** as compared with an internal combustion engine vehicle.
- ▶ Aluminium is the ideal material for battery enclosures since **it is light, crash and intrusion resistant, and manages thermal energy.** As a result, the battery enclosure market could become the largest automotive application for aluminium extrusions by 2025.

A GLOBAL LEADER IN AUTOMOTIVE

23%

of our 2018 revenue came from the automotive market

Some of our clients

- ▶ Audi, BMW Group, Daimler, Fiat Chrysler Automobiles, Ford, General Motors, Jaguar Land Rover, Porsche, PSA Group, Toyota, Volkswagen

Market trends

AUTO BODY SHEET FLAT ROLLED PRODUCTS
Consumption (kt)

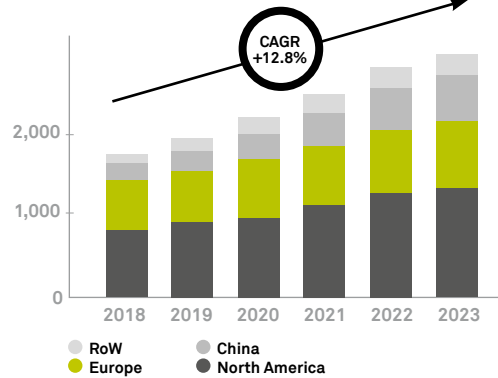

Source: Republished under license from CRU International Ltd., Aluminium Rolled Products Market Outlook November 2018.

ALUMINIUM EXTRUSION DEMAND IN SELECTED AUTOMOTIVE APPLICATIONS
Consumption (kt)

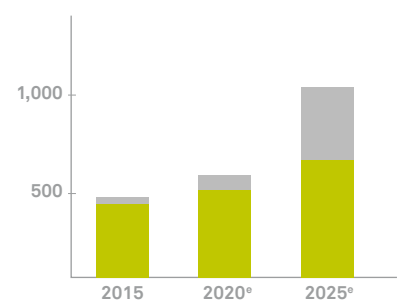

Source: Constellium analysis based on CRU, IHS, Ducker and Bloomberg data.

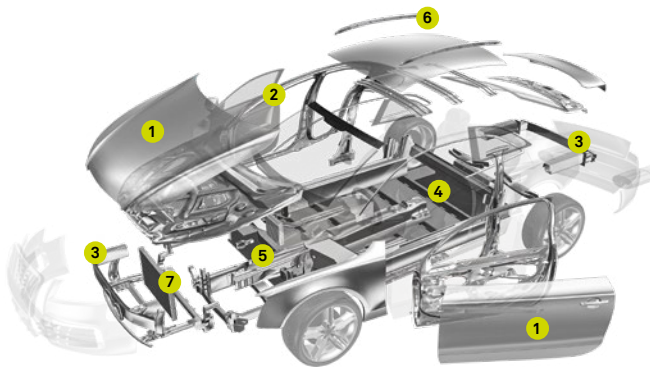

Constellium is uniquely positioned to develop aluminium alloys and produce both flat rolled products and automotive extruded structures that meet the demanding quality and volume requirements of global automakers.

- 1 Car body closures
- 2 Body-in-White
- 3 Crash Management Systems
- 4 Battery Enclosures
- 5 Chassis and Mechanical Parts
- 6 Decorative Parts and Equipment
- 7 Heat Exchangers

Our automotive plants

EXPANDING OUR CAPABILITIES AND OUR FOOTPRINT

- Bowling Green, Kentucky – now a fully owned plant, with a capacity of 100 kt
- Muscle Shoals, Alabama – ramp-up of Auto Body Sheet cold coils
- Neuf-Brisach, France – ramp-up of a 100 kt CALP line
- In 2019, we are opening a plant in Nanjing, China, for the electric vehicle market and in Žilina, Slovakia, for the Eastern European market
- A new casthouse and extrusion line in Děčín, Czech Republic, and a second press in Levice, Slovakia
- Our plants in Dahnfeld and Gotmadingen, Germany, and Nuits-Saint-Georges, France, have been expanded to supply new automotive platforms



AEROSPACE

Helping a growing industry fly high

Our materials and technologies keep the world's aircraft and rocket manufacturers soaring.

As a major provider of pre-machining operations and custom-designed aerospace components, and a producer of many advanced proprietary alloys and technologies, we offer value-added and innovative solutions to our customers.

We create value by vertically integrating the aerospace supply chain, from closed loop recycling to pre-machining parts:

- Simplifying the supply chain and shortening lead times
- Preserving metal value through closed loop recycling of aerospace-grade alloys

A market gaining altitude

Demand for aerospace plates is primarily driven by the build rate of aircraft, which we believe will be supported for the foreseeable future by (i) the necessary replacement of aging fleets by airline operators, particularly in the

United States and Western Europe, and (ii) increasing global passenger air traffic. The aerospace industry publication *The Airline Monitor* estimates that global revenue passenger miles will grow at a compound annual growth rate (CAGR) of approximately **5% from 2018 to 2024**. Demand for aluminium for the North American and European aerospace rolled products markets is expected to grow by **2% per year between 2017 and 2025**.

Pipeline to the sky

Our aerospace teams are focused on developing new products for our long-term, sustainable future as innovation leaders in aerospace. Our product and customer leadership strategy requires a constant flow of high-value products and applications.

• **Tailored performance:** The aerospace industry is continually evolving, so we work in partnership with industry leaders to develop customized aluminium-lithium alloy solutions that deliver top performance while promoting efficient design and clean production processes. Constellium's unique tailor-made technology unlocks the potential of aluminium to deliver top quality and unparalleled performance, lifting our customers' engineering projects to new heights. Airware® is a performance launchpad for the aerospace projects of the future.

• **Brushed Airware® 2198 fuselage** sheets have arrived on the market with a robust, corrosion-resistant surface and an appealing look. Airware sheets offer a lower-weight, higher-performance alternative to other materials.

IN ORBIT



Space launch systems and travel require materials that push the envelope. About 25 years ago we started developing ultra high-performance aluminium-lithium alloys that were quickly adopted by the NASA Space Shuttle. With their unique combination of strength and light weight, our Airware® 2195 and 2050 alloys allow for dramatically more payload and higher orbits. Both have become preferred plate material for structural components of space launchers and crew modules. They are serving major space programs such as SpaceX's Falcon Launchers, NASA Orion Crew Modules, Boeing's Space Launch System, and Blue Origin.

A GLOBAL LEADER IN AEROSPACE

14%

of our 2018 revenue came from the aerospace market

Some of our clients

- ▶ Airbus, Boeing, Bombardier, Dassault Aviation, Embraer, Lockheed Martin, NASA, Pilatus, SpaceX, Blue Origin

Market trends

WORLD'S COMMERCIAL AIRCRAFT FLEET
(Thousands)

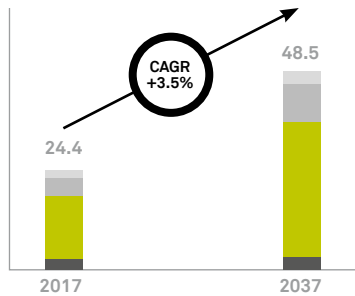

- Freighters
- Single Aisle
- Medium/Large Widebody
- Regional

Source: Boeing 2018 current market outlook.

GLOBAL AEROSPACE DEMAND
Consumption (kt)

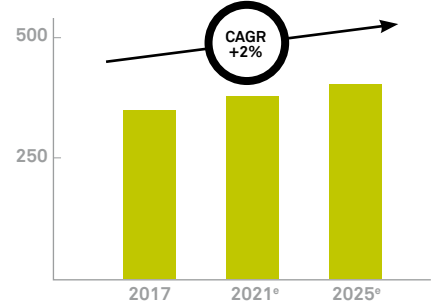

Source: Constellium internal analysis.

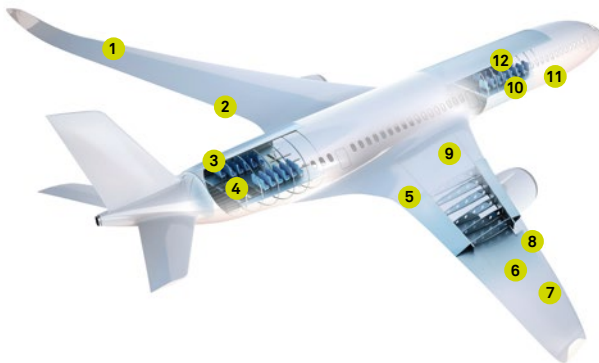

- 1 Upper wing skin panels
- 2 Lower wing skin panels
- 3 Fuselage skin panels
- 4 Fuselage stiffeners
- 5 Landing gear
- 6 Wing spars
- 7 Wing stringers
- 8 Wing ribs
- 9 Center wing box
- 10 Floor beams
- 11 Seat tracks
- 12 Fuselage frames

Our aerospace plants

AN INTEGRATED PLATFORM

- Issoire, France; Ravenswood, West Virginia, U.S.; and Montreuil Juigné, France form an integrated industrial platform with unique capabilities
- Ussel, France, is a sole provider of sand casting high performance aerospace components
- Valais, Switzerland, manufactures high value-added aluminium plates
- Two casting units produce Airware® at the Issoire plant and our Technology Center in Voreppe, France



PACKAGING

A world-leading integrated supplier for the aluminium market

Aluminium is a preferred material for all kinds of packaging. It keeps beverages cold, is flexible and lightweight, can be densely stacked, and is efficient to recycle. Constellium's high-value products range from screw tops to perfume bottles, and we are a major recycler.

We address every facet of the market, from recycling to aluminium coils and sheets:

- Beverage cans
- Food cans
- Bottle closures
- Flexible packaging
- Personal care aerosols
- Cosmetics packaging
- Luxury packaging for the perfume industry



A steady market

In Europe, the market is **expanding by 2.4% per annum**, according to CRU. Two factors are driving this growth. First, aluminium is replacing steel as the standard for beverage cans – between 2002 and 2016, aluminium's penetration of the European canstock market increased from 58% to 85%. Second, with purchasing power on the rise in Eastern Europe, more people are drinking canned beverages.

North America has contrasting trends, resulting in a flat growth rate. There is a decline in consumption of carbonated soft drinks, due to better health awareness in general. This decrease is counterbalanced by growth in Mexico, along with the use of cans in niche markets such as sparkling water, energy drinks, and craft beers.

Innovation is part of the package

We have made great progress in using the drawing and ironing process to develop down gauged aerosols and bottles, thanks to our new prototyping capability at C-TEC and ongoing collaboration with customers.

Our Constellium Technology Center in Voreppe, France, regularly works with customers on innovation. We provide products for the cosmetic packaging industry, from lipstick to perfume caps, where appearance is key. To respond to customers' demands for iridescent parts, Constellium recently developed and patented a new anodizing process. The resulting product changes color from blue to pink to yellow depending on the light, a trait that is highly appreciated by OEMs.

ALUMINIUM IS BORN TO RECYCLE



- ▶ An increased focus on sustainability is expected to boost demand for aluminium cans as a sustainable alternative to plastics in beverage packaging.
 - infinitely recyclable
 - keeps same properties after recycling
 - aluminium's value makes recycling costs worthwhile, compared with other materials
 - recycling used beverage cans saves 95% energy compared with using primary metals
- ▶ This is reinforced by an increase in environmental scrutiny and plastics regulations.
 - European ban on single-use plastics by 2021
 - company announcements on the reduction of plastic packaging and single-use plastics
- ▶ As an aluminium recycling leader, Constellium is well placed to benefit from these trends.

A GLOBAL LEADER IN PACKAGING

40%

of our 2018 revenue came from the packaging market

The numbers tell the story

- ▶ Aluminium is the material of choice for **90%** of the world's beverage cans
- ▶ It takes as little as **60 days** for an aluminium can to return as a new can after recycling
- ▶ We have the capacity to recycle the equivalent of **32 billion** cans at our facilities in Muscle Shoals, Alabama, and Neuf-Brisach, France
- ▶ Our plant in Muscle Shoals, Alabama, has the capacity to recycle the equivalent of about **1/5** of the beverage cans sold in the U.S.

Some of our clients

- ▶ AB InBev, Amcor, Ardagh Group, Ball, Can-Pack, Crown, Coca-Cola, Moravia Cans

Market trends

TOTAL EUROPEAN ROLLED PRODUCTS
Consumption Can Stock (Kt)

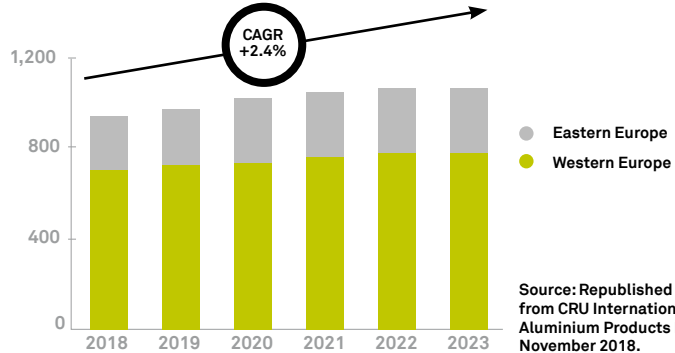

TOTAL NORTH AMERICAN ROLLED PRODUCTS
Consumption Can Stock (Kt)

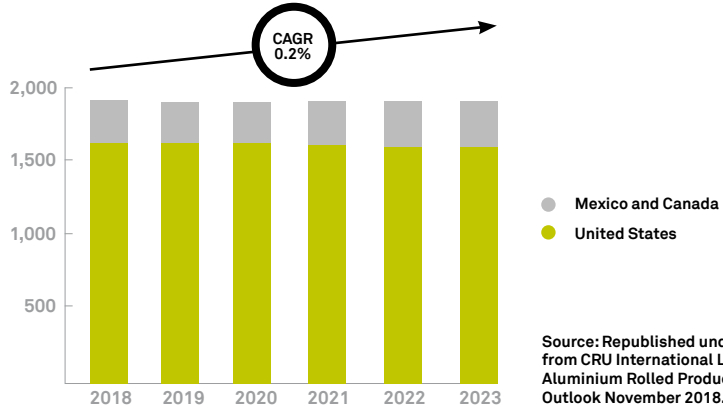

Our plants

WORLD-CLASS CAPABILITIES

- **Muscle Shoals, Alabama** – one of our largest sites with the widest strip mill in the U.S. and a world-class beverage can recycling center
- **Neuf-Brisach, France** – with key positions in beverage can stock (body, end, and tab) and food can stock in Europe, along with a world-class recycling center
- **Singen, Germany** – supplies closure stock to a global customer base. Unique expertise in functional surfaces, particularly appreciated by the luxury cosmetic packaging sector



DEFENSE

Partnering for better protection

Constellium forms partnerships with global defense companies to develop next-generation solutions.



Defense solutions not only need to be effective, they need to improve survivability of personnel. This means producing military aircraft and armored vehicles that are faster, lighter, safer, and more durable.

To help achieve this goal, defense manufacturers place their trust in Constellium as a dependable and innovative technology partner with a proven track record in R&D collaboration and state-of-the-art material solutions.

Military land vehicles

Our lightweight aluminium alloys offer outstanding impact resistance and advanced stiffness properties. They can provide standalone armor protection or serve as part of a multi-material solution, giving manufacturers the flexibility to optimize levels of protection. Constellium's armor product suite is the

broadest global offering of specialized aluminium alloys. With superior performance, aluminium is a highly effective solution for the battlefield, and is the best choice for armored vehicles when superior protection and mobility matter most.

Military aircraft

With our portfolio of advanced alloys (including Airware®) and our collaborative approach, Constellium is a strong partner for the world's military aircraft makers. Our high-performance materials are found in aircraft such as the F-35 Joint Strike Fighter, F-22, F-16, A-10, Eurofighter Typhoon, and Hawk.

Mobile military bridges

Military bridges need to be easily transportable and quickly deployed to enable the movement of vehicles and

people in various terrains and climates, whether for military operations or disaster relief. We work closely with leading customers in the field, and our offering encompasses a complete product portfolio for military bridges, with both flat rolled products (sheet and plate) and extrusions.

SOME OF OUR CLIENTS

- ▶ BAE Systems, Boeing, CMI Defence, CNIM, Dassault Aviation, Embraer, FNSS, General Dynamics, KMW, Lockheed Martin, MBDA, Nexter Systems, Northrop Grumman, Sikorsky, WFEL

TRANSPORTATION

Superior products for road and rail

Constellium supports transportation manufacturers beyond a traditional supplier role, producing value-added products and solutions and managing complex supply chains.

In the transportation industry, every kilogram saved through lightweighting contributes to our customers' bottom lines. We have built upon aluminium alloys' light weight and other intrinsic properties to develop a range of dedicated extrusions, sheets, plates, castings, and semi-finished components for tanker trucks, trailers, trains, tramways, and other modes of transportation.

In addition to aluminium semi-finished products of exceptional quality, we provide our customers with a wide variety of ready-made solutions, components, and tailored services that reduce manufacturing costs and production throughput time.



Commercial trucks and trailers

Constellium's extra-large wide coil offering from our Ravenswood, West Virginia, plant is unique in North America. Our wide coils are ideal for roofs and side panels, since they make it possible to build trailers with single sheets of aluminium, providing greater strength and preventing water leakage into cargo areas.

Rail vehicles

We have a comprehensive railway-specific extrusions offer, developed over 40+ years and with references worldwide. We adhere to the latest quality standards in the aluminium and rail industries, including the International Railway Industry Standard (IRIS).

Our lightweight aluminium solutions give rail vehicle manufacturers a competitive advantage when producing light and energy-efficient railcars. Recently, we helped a European customer develop

and produce the aluminium body shell for a new high-speed train, bringing it from concept to delivery in less than two years. Aluminium casting has been used successfully for decades in powertrain applications, including engine boxes and structural parts such as support beams and bogies. Our Ussel, France, plant specializes in precision casting – one of the fastest, simplest, and most cost-effective ways of shaping complex aluminium parts.

Power rails

Constellium's aluminium-steel co-extruded power rails help guarantee electrical supply to underground and suburban train systems around the planet. Together with our joint venture partner, Pandrol, we design, manufacture, test, and supply conductor rail systems. Our facility in Singen is the only plant in the world to produce aluminium-steel

co-extrusions that supply power to metro rail systems.

Leisure vehicles

Constellium provides a range of products for camping cars and caravans. Wide painted aluminium coils are the material of choice for top-quality leisure vehicles, and our ability to produce very wide painted coils allows for a product range unequalled in the industry, with widths of up to 2,600 mm (102") or more, and thicknesses of up to 2 mm (0.08").

SOME OF OUR CLIENTS

- ▶ Benalu, CAF, Gillig, Hitachi Rail, Hyundai, Kögel, Krone, Schmitz Cargobull, Stadler, Wabash

INDUSTRY

Our applications cover a wide range of products, from building facades to industrial robots. With 100 years in the industry field, we combine experience with world-class manufacturing capabilities to offer our customers the right solutions for their individual requirements.

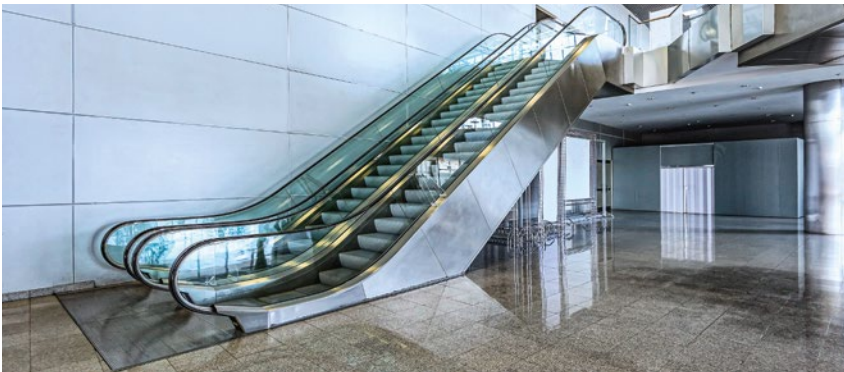

Aluminium affords excellent machinability, weldability, and formability, and has superior thermal and electrical conductivity. Constellium's aluminium sheets, plates, bars, and extrusions serve a variety of industrial applications:

- Premium semi-products for building and architecture
- Components for machinery and industrial robots
- Equipment for processing semiconductors and flat panels
- Molds for shaping plastic objects

In addition to our extensive offer of semi-products, we provide ready-to-use solutions for industrial applications, such as design planks for industrial floors or high-dissipation heat sinks.

Plates that perform

In response to customer demand for high-performance aluminium plates, we launched our new Alplan™ Beyond Precision product line. These specially rolled plates feature up to 15 times better flatness compared with industry

standards and require up to 40% less material. Their stability is higher than that of mill finish plates, reducing part rework by as much as 90%. They have excellent anodizing results, even for typically difficult products. With Alplan™, our customers accelerate the output of production lines; some are able to halve their manufacturing time.

Serious about series production

Building upon Constellium's decades of experience and knowledge of the molding industry value chain, we have developed Alumold®, an excellent alternative to steel molds. These aluminium mold products reduce overall costs and offer significant productivity gains. Alumold® tools allow for shorter cycle times and faster machining, polishing, and engraving times, and are also easy to modify.

Transitioning to Alumold® is seamless, enabling molders and mold makers to operate differently and set a new

standard. Alumold® products are suitable for everything from large series programs to prototyping of all kinds, such as injection tooling, blow molding, and injection molds.

Innovative architecture

With Constellium's extensive knowledge of the building and construction sector, we can deliver the most technologically advanced solutions to our customers. Our solutions meet aesthetic requirements and technical challenges for applications such as facades and interiors, mold construction, doors and windows, ceiling systems, composite applications, high-quality light fittings, solar technologies, and specialty thermal breaks.

A sophisticated surface

Inoxal® offers the sophisticated brushed aspect of stainless steel without its inconvenience. Its durability and corrosion resistance make it ideal for architectural applications while ensuring low lifetime costs. After anodization, the homogeneous surface is abrasion-resistant and can be easily cleaned using a suitable product.

SOME OF OUR CLIENTS

- ▶ Air Torque, Drager, Festo, Metso, Siemens, Thyssenkrupp

SUSTAINABLE VALUE

We strive to keep our footprint light, like the material our business is based upon. We celebrate the inherent sustainability of aluminium, which not only increases efficiency by reducing weight, but can be recycled without losing its properties. We prioritize the safety and well-being of our employees and communities, and we embrace a circular economy for the health of our planet.

OUR SUSTAINABILITY TARGETS FOR 2020

By keeping a progress report of our performance on commitments, we know where we are most likely to succeed and where we must increase our efforts.

PRODUCTS We will enhance the environmental benefits of our products and improve customer satisfaction	PEOPLE We will ensure our people are safe, skilled, motivated, and engaged	OPERATIONS We will minimize the impact of our operations	RESPONSIBLE BUSINESS We will manage our business in an ethical and responsible way
<p>BOOST BEVERAGE CAN RECYCLING</p> <ul style="list-style-type: none"> 80% beverage can recycling rate in Europe ●●○ Work with the industry and with our stakeholders to increase the beverage can recycling rate in the U.S. ●○○ 	<p>FURTHER IMPROVE OUR SAFETY RECORD</p> <ul style="list-style-type: none"> Reduce our Recordable Case Rate* every year by 10% ●●○ A maximum of four serious injuries a year by 2020** ●●○ Be in the industry's top quartile in terms of safety results ●●● 	<p>REDUCE PRODUCTION WASTE SENT TO LANDFILL</p> <ul style="list-style-type: none"> Reduce production waste going to landfill by 10% (vs. 2015) ●○○ <p>IMPROVE ENERGY EFFICIENCY</p> <ul style="list-style-type: none"> 10% energy efficiency improvement by 2020 ●○○ 	<p>BUILD A STANDARD FOR ALUMINIUM</p> <ul style="list-style-type: none"> Have at least one site Aluminium Stewardship Initiative (ASI) certified ●●○ <p>ENSURE SUSTAINABLE PURCHASING</p> <ul style="list-style-type: none"> Evaluate the sustainability performance of all key suppliers ●●○ Undertake on-site sustainability audits of suppliers working in locations and sectors with greater risk of divergent practices ●●○ Ensure that all suppliers sign on to our Code of Conduct ●●○
<p>INCREASE CUSTOMER SATISFACTION</p> <ul style="list-style-type: none"> Conduct a customer satisfaction survey every two years for all business units ●●● 	<p>ENGAGE OUR PEOPLE</p> <ul style="list-style-type: none"> Six-point increase in overall employee satisfaction from a 2014 baseline ●●● <p>STRENGTHEN OUR COMMUNITIES</p> <ul style="list-style-type: none"> At least one community activity per site every year ●●○ 		

* Recordable Case Rate measures the number of fatalities, serious injuries, lost-time injuries, restricted work injuries or medical treatments per one million hours worked.
 ** We did have 3 serious injuries, which is in line with our target, but one was a fatality. We cannot consider this as a target achievement.

- Target achieved
- Significant progress made; on track to achieve the target
- More effort required to achieve the target

ALIGNING OUR INDUSTRY WITH THE UN SUSTAINABLE DEVELOPMENT GOALS

European Aluminium has linked its Sustainability Roadmap to the United Nations Sustainable Development Goals (SDGs), giving Constellium a framework to work on our own.

Connecting the Roadmap to the SDGs

As a member of European Aluminium, 80-plus companies and organizations representing the entire aluminium value chain, Constellium supports the association's Sustainability Roadmap Towards 2025 and we have aligned our sustainability targets with it.

In 2018 our industry decided to link the Roadmap to the SDGs, which we consider a key standard for sustainability. European Aluminium turned to CSR Europe, a business network dedicated to corporate social responsibility, for help in evaluating the Roadmap and identifying goals and actions for 2025 and beyond.

The final report determined that there are clear connections between European Aluminium's sustainability goals and a number of SDGs. It found that we could maximize our industry's positive impact and business opportunities by focusing on eight SDGs in particular: **quality education; gender**

“By linking our Sustainability Roadmap to the SDGs, European Aluminium is striving to make the Roadmap as effective as it can be. Constellium is a valuable partner in this effort.”

Coline Lavorel,

Director Public Affairs and Communications, European Aluminium



equality; affordable and clean energy; decent work and economic growth; industry, innovation, and infrastructure; responsible consumption and production; climate action; and partnerships for the goals.

Areas of Greatest Impact

These SDGs intersect with four areas where our sector has significant economic, environmental, and social impact: **decarbonization through energy efficiency and clean energy, the future of skills and education, circularity and new business models, and collaboration for innovation.**

In practice, we can reduce CO₂ emissions by enhancing energy efficiency and increasing our use of renewables. We can



boost our socio-economic contribution by doing more for our employees and the communities where we operate.

As for collaborative innovation, European Aluminium has an Innovation Hub, a community of companies conducting research for a more sustainable future. One of its actions is finding ways to make products more sustainable and durable. To drive this, the Hub is part of the EU “Factories of the Future” platform.

RESPONDING TO OUR MATERIALITY ASSESSMENT

Constellium conducted its second Materiality Assessment in 2017-2018. By asking internal and external stakeholders, we developed a series of actions to align our sustainability efforts with their priorities.

Human Rights

We strengthened Constellium's human rights and labor practices policies, so that they are aligned with the UN Guiding Principles on Business and Human Rights and other internationally recognized standards. We established these principles not only for our own operations and employees, but for our business partners and suppliers, too. The policy appears in our new Code of Conduct, published in several languages. We also incorporated the topic of human rights into our Responsible Supply Chain Management Policy, implemented via our supply chain due diligence process.

In the fourth quarter of 2018, we launched a human rights due diligence process with the help of Shift, a non-profit organization, to assess existing or potential risks across our operations. Our Sustainability team conducted workshops with the management teams of several of our plants in different business units and geographic locations. At this early stage of the process, we could see that our own operations do not generate major risks of human rights violations, but we identified areas of risk and areas that could be improved, related to the nature of a plant's

operations, its development phase, size, local culture, applicable regulations, and/or social situation.

In April 2019, we organized a global workshop with leadership from different key functions to discuss these risks. It produced a Constellium human rights heat map which was presented to the Executive Committee. Now that we have a global understanding of the risks, we are working on an action plan to mitigate them. Some of our next steps are to provide more extensive training on our Code of Conduct and to work on increasing gender diversity. We are also developing an e-learning course, expected to be available in 2019.

Business Ethics

We reworked our Supplier Code of Conduct to take into account our human rights and labor practices policies, as well as new legislation against corruption. As a result, compliance and sustainability now go hand in hand. Our anti-corruption due diligence process now contains both legal and sustainability requirements, especially in our supply chain.

Communication and Training

We have made progress on both topics. We created onsite sustainability training sessions for Sales, Purchasing, and R&D functions, and an e-learning module is under development. We also increased the frequency of internal communications about our achievements. We communicate regularly with our customers on our sustainability targets and meet with industry associations and NGOs, particularly through our engagement with the Aluminium Stewardship Initiative and multi-stakeholder awareness programs such as Every Can Counts.

Reducing the Impact of Operations

This topic is high on our sustainability agenda, especially the two most material items: reducing landfill waste and increasing energy efficiency. Both are part of our 2020 sustainability targets. We work to ensure that our employees fully understand these concepts and make them part of their daily work routines at all our sites. (See pp. 47-48 for more information.)

Our GHG Target

Reducing our carbon footprint is still a work in progress. We have defined targets for certain sites, but a global approach has proven to be more challenging, due to the evolution of both our production volumes and product mix. We expect to establish an overall target and will communicate it at that time.

“Shift is pleased to support Constellium as the company starts identifying potential human rights risks across its value chain, and exploring ways to mitigate them.”

Susannah McLaren,
Advisor, Shift

THE PRIORITIES OF INTERNAL AND EXTERNAL STAKEHOLDERS

Note: This graph shows only the scores that received a minimum of 8 out of 10 in terms of importance to stakeholders.



- | | | |
|--|---|---|
| 1. ● Recycling | 8. ● Reducing use of harmful substances | 15. ● Business ethics |
| 2. ● Being innovative | 9. ● Reducing GHG emissions | 16. ● Complying with public policies |
| 3. ● Improving customer satisfaction | 10. ● Energy efficiency | 17. ● Enforcing freedom of association |
| 4. ● Developing products with environmental benefits | 11. ● Increasing economic performance | 18. ● Preventing child labor |
| 5. ● Ensuring gender equity* | 12. ● Reducing landfill waste | 19. ● Responsible purchasing |
| 6. ● Improving safety at work | 13. ● Preventing forced/compulsory labor | 20. ● Transparency and respect of confidentiality |
| 7. ● Preventing pollution | 14. ● Enforcing the respect of human rights | |

*We included this topic in the matrix because of its high rating despite the small number of external stakeholders who rated it (10).

SUSTAINABILITY HIGHLIGHTS



▲ Muscle Shoals operators signing up for events at the Communication Station.

Communication Station

Our Muscle Shoals factory is a huge site with **1,200+ employees**, around one-third of whom lack a business email address. Seeking to bring managers closer to employees, especially those on the shop floor, the Communications team interviewed employees about their needs, then created and manufactured 27 **“Communication Stations.”** Located in break rooms, these stations display announcements about everything from EHS to financial performance, human resources, and employee events such as the Family Fun Day picnic or Walk for Alzheimer’s. Each Station includes a drop box for donations to the Constellium Cares community engagement program. In 2019 we will add **interactive tablets** so that employees can register for training, look for internal job postings, access EHS information, or simply browse our intranet.

“It is the first thing we turn to when we come in the break room. It is vital to how we know what goes on in the plant.”

Kenny Greenhill,
Cathouse Production Operator, Muscle Shoals



Airbus approves

Airbus created the SQIP (Supply Chain & Quality Improvement Program) challenge in 2015 to **track its suppliers’ performances**, product quality, and ability to meet deadlines. Since then, our Ravenswood, Montreuil-Juigné, and Issoire plants have greatly improved their production, supply chain, and quality performances.

As a result of these efforts, Constellium received a **2018 award for “Best Improver”** at Airbus’ headquarters in Toulouse.



In 2018, we saw the full **roll-out of MOMENTUM**, a company-wide program to communicate our mission, strategy, and values to employees.



BEFORE

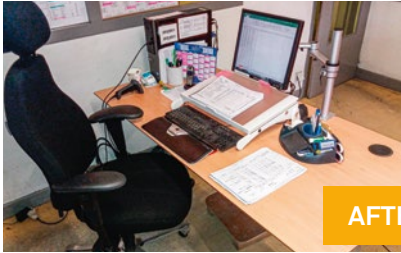

AFTER

THE ABILITIES OF ALL

Constellium Ussel reached the legal requirement of 6 percent of disabled employees in 2018, and went even further by working with Cap Emploi 19 and Agefish Limousin to adapt jobs to different abilities. **In 2019, Ussel is pursuing its commitment to open its doors to all workers** and accommodate diversity within the plant with a program called RQTH – *Reconnaissance de la qualité de travailleur handicapé* (Recognizing the qualities of disabled workers).



▲ Left to right: Jiří Palma, Plant Manager, Ondřej Pech, Central Maintenance EHS Coordinator – representative winner team 2018, Ondřej Lahodný, Environmental Specialist

(Environmentally) Friendly competition

Our Děčín plant discovered that a spirit of competition can be a great boost to sustainability efforts. Since 2008, the plant has hosted an employee contest to **spark enthusiasm for environmentally friendly measures** while encouraging better business practices. The contest is organized into categories, encouraging workers to prevent environmental incidents or unnecessary pollution, use fewer hazardous chemicals, produce less waste, and reuse and recycle. (The categories can be modified according to the plant's needs.) Results are published quarterly and the competition lasts one calendar year, at the end of which winners receive awards in each category. Best of all, the contest has produced serious results – for example, **Děčín's employees now recycle more than 90% of the plant's waste.**



▲ Carole Pettre, Supply Chain and Quality Improvement Program leader, Issoire

Closing the gender gap

French law now requires all companies with at least 1,000 employees to measure salary differences between women and men through a gender equality index. Our sites at **Issoire and Neuf-Brisach both performed well** for the 2018 reporting period, with an overall score of 86/100 and 84/100 respectively, both comfortably above the required minimum. Each plant scored particularly well on promotions and salary increases of women. We are now looking at proactively increasing the number of women on the shop floor and in engineering and management positions at both plants, and more generally throughout the group.

INCREASING RECYCLING RATES

Constellium works to improve aluminium beverage can recycling rates in Europe and North America in a variety of ways: by supporting education and promotion, creating partnerships with organizations, conducting studies, gathering data, and influencing legislation.

We participate in the European Aluminium Packaging Group's efforts to increase aluminium recycling rates, and are pleased to see that this collective undertaking is paying off. Throughout the continent (EU 28 + EFTA), there is an upward trend in beverage can recycling rates, which vary from one country to another. In 2015, it reached a record level of 73.6%, just shy of European Aluminium's voluntary 75% target, and on track to reach the 2020 target of 80%.

Our industry's efforts take place on two fronts. One is legislative: the European Aluminium Packaging Group, supported by the association, lobbies European Union legislators to ensure that the law helps boost aluminium packaging recycling rates, particularly for beverage cans. A recycling roadmap for aluminium cans is expected to be published in 2019. The member states are now working on implementation of the Circular Economy Package. We also reach consumers through education and communication. For example, the Every Can Counts (ECC) program, now present in 15 countries,



▲ "Pixelata," a wall image created from 2,000 beverage cans for Every Can Counts

encourages beverage can recycling on the go. Thanks to recycling at festivals and events, a women's cycling team partnership, and social media campaigns, beverage can recycling continues to increase. While aluminum beverage cans remain the most recycled beverage packaging

"In 2019, Every Can Counts celebrates its 10th birthday and reaffirms the industry's voluntary commitment to recycle every beverage can across Europe."

Ramon Arratia,
Public Affairs and Sustainability Director, Ball Beverage Packaging Europe, and Chair, Every Can Counts

type in the United States, recycling rates are lower than in Europe. Together with the Aluminum Association and the Can Manufacturers Institute, and in collaboration with canmakers and can sheet producers, we are working to improve data collection and shape legislation.

2020 TARGET	2018 ACCOMPLISHMENTS	NEXT STEPS
 • 80% beverage can recycling rate in Europe  • Increase beverage can recycling rate in U.S. 	• Published in 2018, the average aluminium can recycling rate in Europe reached 73.6% in 2015	• Further support European and U.S. Industry programs to increase aluminium packaging recycling

ENSURING CUSTOMER SATISFACTION

Constellium is constantly looking for ways in which our products and services can better **anticipate and respond to our customers' needs**. In 2018, our three business units conducted their latest customer satisfaction surveys. Positive results reflected our efforts and showed **we are on the right path**.



▲ We supply the Airbus A350

“Your average on-time delivery score over the last three months was 100 points. This is an excellent score, and we know it is well deserved.”

Marc Ploeg,
Purchaser, Voestalpine Automotive Components Bunschoten B.V.

Aerospace and Transportation received very high marks in 2018, with 88% of customers saying they are satisfied with our products and services – notably sustainability, sales, products, and technical support. Packaging and Automotive Rolled Products also saw a rise in satisfaction, especially for technical support/claims management and supply chain.

Automotive Structures and Industry continues to serve customers' needs by reducing time-to-market and developing new lightweighting solutions for all

types of vehicles. In 2018 we added prototyping and testing aluminium automotive components to our services at the University Technology Center in Brunel. We were especially pleased by Constellium's Net Promoter Score (NPS), which asks customers if they would recommend a company as a supplier. All of our business units performed significantly above the industry benchmark.

Focus on customers

Constellium is deepening our relationship with Daimler by supplying the new

Mercedes-Benz A-Class with Crash Management Systems and structural components. For Audi, another long-time customer, we are the primary supplier of automotive body sheets for closures and inner parts of the new A6. We also expanded our Dahenfeld, Germany, plant to supply a new premium sports car with advanced aluminium structural assemblies.

We have been flying high ever since the Airbus Supply Chain and Quality Improvement Program (SQIP) recognized Constellium with its “Best Improver” award.

2020 TARGET	2018 ACCOMPLISHMENTS	NEXT STEPS
 <ul style="list-style-type: none"> • Conduct a customer satisfaction survey every two years for all business units 	<ul style="list-style-type: none"> • All business units conducted customer surveys and implemented actions based on the results 	<ul style="list-style-type: none"> • Sustain the same high level of satisfaction and close collaboration with customers

FOCUSING OUR EFFORTS ON SAFETY

Safety is at the heart of everything we do. We are constantly looking for ways to improve upon EHS, and rolled out **our Serious Injury and Fatality (SIF) Prevention program**, a top priority, in 2018. At the same time, we highlighted the importance of **our Golden Rules and employee peer-to-peer interaction**.

Our 2018 safety record gave us many reasons to be proud. Our 2.28% recordable case rate was an improvement over 2017 and 21% better than our target. Two of our plants, Singen Extrusions and Děčín, reached 1.5 million working hours without a recordable case, while three others reached a one-million-hour milestone. Six plants finished the year without a single recordable injury case. Serious injury cases decreased from 14 in 2017 to three in 2018. Tragically, one was a fatality, at our Neuf-Brisach plant. This terrible incident proved that we must keep working to enhance our SIF program, the observance of Golden Rules, and peer-to-peer interaction (“see something, say something”).

Our 14th annual EHS FIRST Day was held on September 18, and focused on our ongoing efforts to prevent serious injuries and fatalities. A new video with messages from the CEO and the plant manager of Neuf-Brisach highlighted the importance of SIF. We launched the EHS FIRST leadership training program



▲ A team leader explains the Golden Rules to his colleagues on our annual EHS FIRST Day

in September, training 52 managers in key leadership positions at our plants in Singen, Van Buren, Issoire, and Neuf-Brisach.

Videos and testimonials are a great tool for safety awareness and for changing behaviors by reaching people at an emotional level. We have been using videos to train operators in subjects

such as SIF risks and line-of-fire hazards. The EHS network also learned to make their own videos with a smartphone app.

In addition, we held two EHS networking meetings, at Děčín and Muscle Shoals, attended by site management and staff. Both meetings featured site visits and shop floor exercises as well as shared practice competitions.

2020 TARGET	2018 ACCOMPLISHMENTS	NEXT STEPS
 <ul style="list-style-type: none"> • Reduce Recordable Case Rate* by 10% annually • No more than 4 serious injuries a year • Be in the industry's top quartile for safety results 	<ul style="list-style-type: none"> • A drop in our recordable case rate to 2.28% • The number of serious injury cases decreased from 14 in 2017 to 3 in 2018 	<ul style="list-style-type: none"> • Keep reducing our recordable case rate • Higher maturity of SIF prevention process • Better employee peer-to-peer interaction

* Recordable Case Rate measures the number of fatalities, serious injuries, lost-time injuries, restricted work injuries, or medical treatments per one million hours worked.

ENGAGING OUR PEOPLE

We accomplished **two major employee engagement goals in 2018**. Our Global Employee Survey was a success, showing that our people are increasingly **satisfied at work**. The year also saw the full roll-out of MOMENTUM, a company-wide program to communicate our mission, strategy, and values to employees.

More than 9,000 employees responded to our 2018 survey, for a record participation rate of 78%. We noted progress in all categories and statistically significant improvement overall compared with prior surveys in 2014 and 2016.

We even outperformed our 2020 target with a 10-point increase in employee satisfaction, compared with the 2014 baseline. With a nine-point gain for the “Leadership” related questions, the survey showed that our employees better understand how the company plans to move forward and the role they play in our goals. We took particular pride in the number of employees who would recommend Constellation as a good place to work, a score that rose by nine points. All sites shared their results with management and employees. They defined local action plans linked to training and development, EHS, leadership, and company culture; more than half of the actions are already being implemented. Our MOMENTUM program also gained traction. In the U.S., Ravenswood, WV has trained its leadership team and is now training employees. Automotive Structures North



▲ For casthouse employees at Issoire, “collaboration is team work promoting mutual assistance, listening, communication, and solidarity”

America provided training sessions to salaried and hourly employees. Van Buren, MI, and White, GA, created safety helmet stickers with MOMENTUM values to raise awareness. In Europe, C-TEC and Issoire organized focus groups to discuss

“MOMENTUM is a way for Ravenswood to walk the walk. Actions speak louder than words.”

Hannah Bolyard,
HR Business Partner, Ravenswood

“Respect is the most important value to me. Treat others as you would like to be treated, plain and simple.”

Brianna Montgomery,
Purchasing Analyst, Van Buren

MOMENTUM’s values, and Issoire created an in-house contest. The Neuf-Brisach plant is using MOMENTUM’s video as briefing material for recruitment agencies. At Singen, MOMENTUM is part of the onboarding process for new hires.

2020 TARGET	2018 ACCOMPLISHMENTS	NEXT STEPS
 <ul style="list-style-type: none"> • A six-point increase in employee satisfaction vs. 2014 	<ul style="list-style-type: none"> • A 10-point increase in employee satisfaction in the Global Employee Survey • Full roll-out of MOMENTUM 	<ul style="list-style-type: none"> • Continue to implement local action plans based on the survey results

STRENGTHENING COMMUNITIES

Our sites **support their local communities** in a variety of different ways. Constellium employees around the world proudly volunteer their time and effort to **improve the lives of others.**

In 2018, Ravenswood once again organized the “Paint the Plant Pink” initiative, hosting a 5 km run to support the American Cancer Society. Ravenswood employees volunteered for Habitat for Humanity, permitting underprivileged families to obtain safe, suitable housing, and they helped retirees to maintain their yards. Van Buren participated in a run for St. Jude Children’s Research Hospital. The plant also supports Toys for Tots, Gleaners Community Food Bank, and the Ronald McDonald House of Ann Arbor, which houses the families of children receiving medical treatment.

In White, Georgia, plant managers played games and conducted team-building exercises with adults with intellectual and developmental disabilities at Hickory Log Vocational School.

Our employees in Mexico spent a day with orphaned children, collected Christmas toys for children with cancer, and helped with upkeep at the local orphanage.

Constellium Paris ordered Christmas baskets from a company that employs mostly handicapped people, and



▲ San Luis Potosí plant Open Day

donated 80 to underprivileged people through another association. At Issoire, employees raced for hospitalized children and to fight breast cancer. Issoire signed an agreement to accommodate its employees in the military reserve, and many employees turned out to support the local Ailes & Volcans aeronautic event. Singen and Gottmadingen employees participated in the Stadtradeln event, leaving their cars

at home for 21 days and cycling to work to build climate awareness. They also ran in a charity event for the disabled in BeTreff Lauf. Constellium partnered with American Corporate Partners (ACP) to help veterans transition to the private sector. Volunteers from Ravenswood, Muscle Shoals, Van Buren, White, Bowling Green, and Baltimore serve as mentors, providing advice on their long-term career development.

2020 TARGET



• At least one community activity per site every year



2018 ACCOMPLISHMENTS

• Most of our sites conducted a community program or event

NEXT STEPS

• Continue to develop community programs at all sites

MINIMIZING LANDFILL WASTE

Although **we increased our production in 2018** and produced 3,000 metric tons more waste than in 2017, our **landfill waste decreased by 2%**. And yet we must **reduce it by 20% more** to reach our 2020 target. To do so, we are pursuing action plans and finding ways to get everyone involved.

In 2018 we maintained a recycling rate of 80% and an incineration rate of 4%, while sending 16% of waste to landfill. The landfill waste we create is technically difficult to recycle and mostly concentrated at large sites that lack proper measures for dealing with municipal waste. To reduce it, Ravenswood is considering recycling baghouse dust, while Muscle Shoals is appointing a specialized contractor to manage waste and recycling of refractory bricks, wood, and baghouse dust. Muscle Shoals also hopes to improve municipal waste sorting and to recycle the less reactive types of sludge.

Many sites have made good progress. Ravenswood initiated a program to address most of the flue gas dust it produces. Ussel started evacuating sand that cannot be recycled, and should remove the last of it in 2019. At Issoire, the salt slag is being recycled again after a year-long break. However, it will be challenging to achieve the target at Issoire and Neuf-Brisach if we are unable to find a



▲ Ussel started evacuating sand that cannot be recycled, and should remove the last of it in 2019

“Through better tracking and waste mapping, Muscle Shoals reduced its 2018 landfill by over 3 million pounds. By partnering with a waste contractor and educating our employees on this culture change, we are confident of achieving our goals.”

Benjamin Yancey,
Director Environmental Services,
Muscle Shoals

sustainable solution for recycling flue gas dust, sludge, and bricks from furnaces. Another challenge is to reduce the amount of waste sent to landfill at U.S. sites. We have seen that a competitive spirit can help motivate

people. Some years ago, we started a recycling contest at Děčín, challenging workers to separate recyclable components of mixed municipal waste. As a result, the site’s waste recycling has risen to over 90%.

2020 TARGET	2018 ACCOMPLISHMENTS	NEXT STEPS
 <ul style="list-style-type: none"> • Reduce production waste going to landfill by 10% vs. 2015 	<ul style="list-style-type: none"> • The quantity of waste sent to landfill decreased by 2% vs. 2017 (but was still above 2015 levels) 	<ul style="list-style-type: none"> • New waste management contract at Muscle Shoals • Find technical solutions for specific production waste such as sludge, flue-gas dust, and refractory bricks

BOOSTING OUR ENERGY EFFICIENCY

We saw **excellent performance in 2018** and reached the year’s target for energy efficiency, improving it significantly at all business units and partially offsetting two years of underperformance. **We must continue to seize all potential energy-saving opportunities** in order to reach **our 2020 goal**.

A general improvement in energy efficiency resulted from the actions undertaken at all our plants, including equipment efficiency, recovery increase, process monitoring, and better use of furnaces.

As for individual sites, our efforts produced the best results at Ravenswood, Issoire, Singen, and Valais. Muscle Shoals, whose energy consumption accounts for a significant portion of the Group total, started to make progress, especially in the second half of 2018. We expect this trend to continue with the site’s recent decision to join the U.S. Department of Energy “50001 Ready” program for energy management.

Aerospace and Transportation was ahead of target at most plants. Some success stories really stood out, such as superior performance at Issoire resulting from several major projects: state-of-the-art high capacity holding and melting furnaces, electromagnetic stirring for melting furnaces, optimized





▲ Issoire’s state-of-the-art holding and casting furnaces, equipped with electromagnetic stirring for better energy efficiency.

production routes, LED lighting, improved management of heating and air conditioning, and more. At Ravenswood, the end of the ramp-up period for the new pusher furnace and better production efficiency contributed to strong global improvement as well.

Going forward, we expect every plant to put the necessary resources into managing energy efficiently, and to ensure that its energy action plan is in line with our 2020 target.

“Energy efficiency is not only investment related. Improving everything we do – equipment performance, recovery, process control – has a significant impact on energy consumption.”

Philippe Hoffmann,
Vice President Aerospace and Transportation Rolled Products Europe

2020 TARGET	2018 ACCOMPLISHMENTS	NEXT STEPS
 <ul style="list-style-type: none"> • 10% energy efficiency improvement vs. 2015 	<ul style="list-style-type: none"> • Improved energy efficiency by 4.7% over 2015, the equivalent of 270 GWh in energy savings 	<ul style="list-style-type: none"> • Focus on the less-performing sites • Identify and share more energy efficient solutions • Continue to look for new opportunities to save energy in all areas of activity

WORKING TO ACHIEVE ASI CERTIFICATION

2018 marked the first full year of certification implementation for the Aluminium Stewardship Initiative (ASI), a global, non-profit, multi-stakeholder organization for aluminium standards and certification. A founding ASI member, Constellium is working to have **our first site certified in 2019**.

Constellium has been an active member of ASI since its beginning, helping the organization to achieve its goal of maximizing aluminium's contribution to a sustainable society. In December 2017, ASI successfully launched its certification program, which comprises a Performance Standard and a Chain of Custody Standard.

In 2018, ASI issued 10 certifications to companies representing different parts of the aluminium value chain. They also accredited seven more auditor firms. These independent auditors are responsible for administering ASI certifications, and now cover nearly every region where there is aluminium activity.

ASI had other positive new developments in 2018. Eighteen new members joined the organization, for a total of 76 members and counting. By demonstrating commitment to its Code of Good Practice, ASI became an associate member of the ISEAL

Alliance, the global association for sustainability standards.

Constellium was equally busy in 2018. We established a project team consisting of corporate and local members to work on certification for our Singen site. We set up a steering committee to ensure internal synergy and coherence so that we can get a head start on certifying our Neuf-Brisach plant as well.

An independent auditor performed a pre-audit of the Singen plant, and we used the results to work on closing any gaps in certification criteria. We continued to improve implementation of our Human Rights and Labor Practice Policy, including due diligence at Group level. We are making progress in applying our responsible purchasing policy to our supply chain, an important criteria for ASI certification.

To ensure our position as sellers of ASI metal, we collaborated with our key suppliers, encouraging and helping

“The efficient use of resources is key to our business, and ASI’s principles are in line with what we do. We were very interested when Constellium suggested we join ASI, and Singen has been quite helpful with the process.”

Markus Wild,
Managing Director, Stockach Aluminium GmbH

them to join ASI. Among these, the Stockach Aluminium recycling plant became an ASI member at the end of 2018, and will now aim for certification. We also started discussions with several key metal suppliers and hope to work together for their certification in the near future.

2020 TARGET



- Have at least one site ASI certified



2018 ACCOMPLISHMENTS

- A Performance Standard pre-audit of the Singen site was conducted
- The first full year of ASI certification implementation following its launch in 2017

NEXT STEPS

- Have at least one plant certified for the Performance Standard
 - Receive certification for the Chain of Custody Standard
- Ensure we are well positioned to sell ASI certified metal

COMMITTING TO RESPONSIBLE PURCHASING

We must ensure that **sustainability is practiced at every step of our business**, including the supply chain. That's why Constellium seeks to work exclusively with **suppliers who comply** with applicable laws and adhere to sustainable practices in governance, the environment, and society.

Constellium published its responsible supply chain management policy in 2017, clearly stating our approach and setting out rules for the Group and our suppliers.

Among its requirements, all contracted suppliers are to sign on to our Supplier Code of Conduct, which outlines our expectations of supplier behavior regarding the environment, society, business ethics, human rights, and labor practices. We updated this document in 2018 based on the latest supply chain laws and internationally recognized standards. Notably, the sections on human rights and business ethics are now more comprehensive.

We ask key suppliers to perform a self-assessment every three years using the EcoVadis platform. As for those whose locations or sectors put them at greater risk of divergent practices, we perform an onsite workplace audit every three years. We organize webinars to make sure our suppliers understand the reasons

for these actions and the processes to follow. And we train our purchasing teams, giving them the tools and knowledge to bring suppliers on board and accompany them throughout the process.

In 2018, we made substantial progress in conducting these evaluations with our metal and energy suppliers, and expanded our scope to include key suppliers to our main sites. We asked 44 suppliers to go through the EcoVadis assessment, and carried out one onsite audit. We also helped suppliers take corrective actions recommended by the assessment or audit when necessary.

Constellium's own EcoVadis rating has continuously improved since 2013, thanks to our responsible purchasing practices. Supplier assessment is not simply a perfunctory exercise for us. We see it as an opportunity to work together for continuous improvement, and we believe it helps to build strong, long-term relationships.

“Through the workplace condition assessment we learned about sustainability trends in the industry, which will help us to keep improving and working better with customers.”

Sue Fu,
Deputy General Manager, Tianqi Lithium

“We worked hard to convince our key metal suppliers to participate in improving our business' sustainability. We are proud of what we achieved.”

Thierry Chiarami,
Senior Sourcing Manager, Rolling Slabs and Extrusion Billets, Constellium

2020 TARGET



- Evaluate key supplier sustainability performance
- Undertake onsite audits of at-risk suppliers
 - Ensure contracted suppliers sign our Code of Conduct



2018 ACCOMPLISHMENTS

- Updated our Supplier Code of Conduct, asked more suppliers to sign off
- Performed 44 new EcoVadis evaluations
- Conducted one onsite Workplace Condition Assessment and worked with previously audited suppliers on corrective actions

NEXT STEPS

- Continue to implement our responsible supply chain management policy, including asking for sign-offs on our new Supplier Code of Conduct and conducting due diligence

ADDRESSING GREENHOUSE GAS EMISSIONS

At Constellium, we monitor and disclose our greenhouse gas (GHG) emissions, and have been doing so for years. In 2018, our GHG emissions remained globally stable or decreased slightly, even though our production volumes rose and our product mix evolved towards more energy-intensive products.

Improved energy efficiency is how we work to decrease our scope 1* and scope 2* emissions, since most are related to energy use. We saved over 60,000 metric tons of CO₂-equivalent emissions in 2018 versus 2015, thanks to our energy efficiency program.

We also aim to reduce emissions indirectly by improving the life cycle performance of products. First, we work on better product design – for example, lighter parts for automobiles and other transportation to reduce fuel consumption. Second, we recycle pre- and post-consumer aluminium scrap, since recycling produces much lower emissions than primary metal production.

Life cycle analyses demonstrate the benefits of both approaches.

Beyond these key actions, we also offer services to optimize the value chain in other areas. For instance, thanks to our machining facilities at our aerospace

plants, we are able to provide pre-machined parts, allowing our customers to generate less scrap. The off-cuts and chips generated by pre-machining are then recycled at our plants, thus limiting CO₂ emissions linked to transportation.

It must be noted that all the aforementioned life cycle gains come at the price of higher GHG emissions in our company (scope 1 and 2), while reductions of emissions associated with our activity occur mostly outside our plants. This largely explains why our energy use and GHG emissions are not decreasing as fast as our energy efficiency is improving. GHG target frameworks recommend that avoided emissions not be counted, and we acknowledge the potential issue of double counting. However, we find that disregarding certain avoided emissions is problematic for companies engaged in recycling and other positive actions that come at the price of higher emissions in their own purview.

NEXT STEPS

- ▶ Continue to work on energy efficiency, as this is the core of our activity
- ▶ Define an emissions reduction target for Constellium
- ▶ Ensure that Singen, Gottmadingen, and Dahlenfeld reach their target by 2020

Our Singen, Gottmadingen, and Dahlenfeld sites have jointly committed to a 10% GHG emissions intensity reduction from 2015 to 2020. We expect this target to be met thanks to our energy efficiency improvement program at each site.

GREENHOUSE GAS (GHG) EMISSIONS (kt CO₂eq)

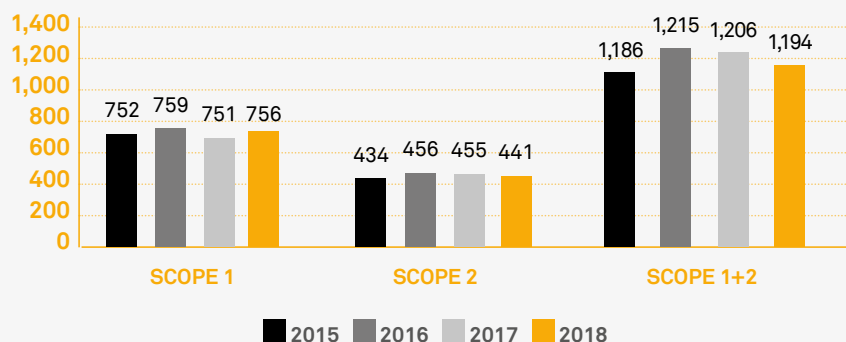

SCOPE DEFINITIONS*:

SCOPE 1:
Direct emissions from sources we own or control

SCOPE 2:
Indirect emissions from production of the energy we purchase (electricity)

PERFORMANCE REPORT

Consolidated income statement • Consolidated statement
of financial position • Consolidated statement of cash flows
• Share information • United Nations Global Compact
Communication on Progress • GRI content index

FINANCIAL STATEMENTS

Consolidated income statement

(in millions of euros)	Year ended December 31, 2018	Year ended December 31, 2017	Year ended December 31, 2016
Revenue	5,686	5,237	4,743
Cost of sales	(5,148)	(4,682)	(4,208)
Gross profit	538	555	535
Selling and administrative expenses	(247)	(247)	(253)
Research and development expenses	(40)	(36)	(31)
Restructuring costs	(1)	(4)	(5)
Other gains / (losses) - net	154	70	21
Income from operations	404	338	267
Finance costs - net	(149)	(260)	(188)
Share of loss of joint-ventures	(33)	(29)	(14)
Income before income tax	222	49	65
Income tax expense	(32)	(80)	(69)
Net income / (loss)	190	(31)	(4)
Net income / (loss) attributable to:			
Equity holders of Constellium	188	(31)	(4)
Non-controlling interests	2	-	-
Net income / (loss)	190	(31)	(4)

Earnings per share attributable to the equity holders of Constellium

(in euros per share)	Year ended December 31, 2018	Year ended December 31, 2017	Year ended December 31, 2016
Basic	1.40	(0.28)	(0.04)
Diluted	1.37	(0.28)	(0.04)

Note: More detailed information on our financial performance can be found in our Annual Report on Form 20-F at: <https://www.constellium.com/investors/sec-filings>

Consolidated statement of financial position

(in millions of euros)	At December 31, 2018	At December 31, 2017
Assets		
Current assets		
Cash and cash equivalents	164	269
Trade receivables and other	587	419
Inventories	660	643
Other financial assets	30	69
	1,441	1,400
Non-current assets		
Property, plant and equipment	1,666	1,517
Goodwill	422	403
Intangible assets	70	68
Investments accounted for under the equity method	1	1
Deferred income tax assets	163	164
Trade receivables and other	64	48
Other financial assets	74	110
	2,460	2,311
Total Assets	3,901	3,711
Liabilities		
Current liabilities		
Trade payables and other	968	930
Borrowings	57	106
Other financial liabilities	60	23
Income tax payable	8	11
Provisions	46	40
	1,139	1,110
Non-current liabilities		
Trade payables and other	27	54
Borrowings	2,094	2,021
Other financial liabilities	29	43
Pension and other post-employment benefit obligations	610	664
Provisions	94	113
Deferred income tax liabilities	22	25
	2,876	2,920
Total Liabilities	4,015	4,030
Equity		
Share capital	3	3
Share premium	420	420
Retained deficit and other reserves	(545)	(750)
Equity attributable to equity holders of Constellium	(122)	(327)
Non-controlling interests	8	8
Total Equity	(114)	(319)
Total Equity and Liabilities	3,901	3,711

Consolidated statement of cash flows

(in millions of euros)	Year ended December 31, 2018	Year ended December 31, 2017	Year ended December 31, 2016
Net income / (loss)	190	(31)	(4)
Adjustments			
Depreciation and amortization	197	171	155
Finance costs - net	149	260	188
Income tax expense	32	80	69
Share of loss of joint-ventures	33	29	14
Unrealized losses / (gains) on derivatives - net and from remeasurement of monetary assets and liabilities - net	86	(54)	(74)
(Gains) / losses on disposal	(186)	3	10
Other - net	14	7	(14)
Interest paid	(129)	(185)	(174)
Income tax paid	(23)	(18)	(14)
Change in trade working capital			
Inventories	(9)	(99)	(42)
Trade receivables	(145)	(91)	28
Trade payables	(27)	124	(18)
Margin calls	(5)	—	—
Change in provisions and pension obligations	(58)	(24)	(26)
Other working capital	(53)	(12)	(10)
Net cash flows from operating activities	66	160	88
Purchases of property, plant and equipment	(277)	(276)	(355)
Acquisition of subsidiaries net of cash acquired	—	—	21
Proceeds from disposals net of cash	200	2	(5)
Equity contribution and loan to joint-ventures	(24)	(41)	(37)
Other investing activities	10	23	11
Net cash flows used in investing activities	(91)	(292)	(365)
Net proceeds received from issuance of shares	—	259	—
Proceeds from issuance of Senior Notes	—	1,440	375
Repayment of Senior Notes	—	(1,559)	(148)
(Repayments) / proceeds from revolving credit facilities and other loans	(68)	29	(69)
Payment of deferred financing costs and exit fees	—	(118)	(19)
Transactions with non-controlling interests	—	—	(2)
Other financing activities	(14)	10	8
Net cash flows (used in) / from financing activities	(82)	61	145
Net (decrease) / increase in cash and cash equivalents	(107)	(71)	(132)
Cash and cash equivalents - beginning of year	269	347	472
Cash and cash equivalents classified as held for sale - beginning of year	—	—	4
Effect of exchange rate changes on cash and cash equivalents	2	(7)	3
Cash and cash equivalents - end of year	164	269	347

SHARE PRICE EVOLUTION IN US\$

(FROM APRIL 2018)

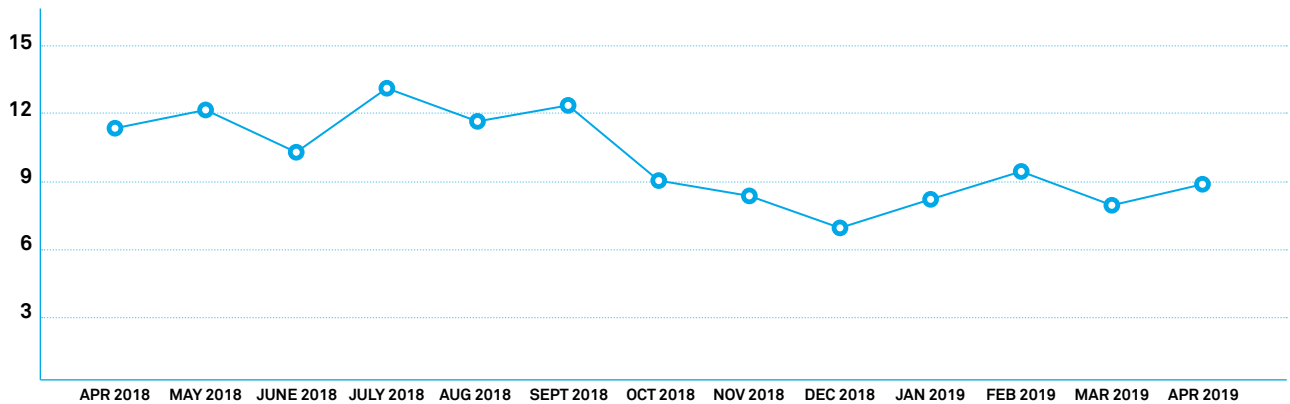

SHAREHOLDING STRUCTURE

(as of December 31, 2018)

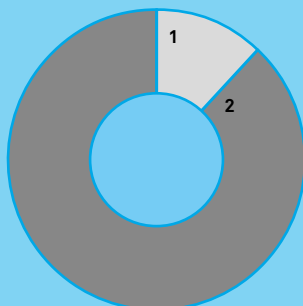

1. Bpifrance 12.1%
2. Free float 87.9%

AVERAGE NUMBER OF DAILY SHARES TRADED IN 2018

1.1 MILLION

SUSTAINABILITY PERFORMANCE

United Nations Global Compact (UNGC) Communication on Progress (CoP) - GC Active

In 2018, we published our Human Rights Policy and Labor Practices, which is aligned with the UN Guiding Principles on Business and Human Rights. The principles in the Policy have been integrated into our new Employee Code of Conduct, and we have launched a human rights due diligence process, to assess existing or potential risks across our operations.



	page	Cross reference / additional information
CEO COMMITMENT OF UNGC	14-15	Interview
HUMAN RIGHTS		
Principle 1: Businesses should support and respect the protection of internationally proclaimed human rights;	22, 36, 38-39, 44, 49	In 2018, we published our Human Rights Policy and Labor Practices, which is aligned with the UN Guiding Principles on Business and Human Rights. The principles in the Policy have been integrated into our new Employee Code of Conduct, and we have launched a human rights due diligence process, to assess existing or potential risks across our operations. Governance-Sustainability Council, Our Sustainability Target for 2020, Responding to our materiality assessment, Focusing our efforts on safety, Working to achieve ASI certification, Committing to responsible purchasing, and our Code of Conduct: https://www.constellium.com/sustainability/downloads/policies-codes-conduct
Principle 2: make sure that they are not complicit in human rights abuses.	50	
LABOUR		
Principle 3: Businesses should uphold the freedom of association and the effective recognition of the right to collective bargaining;		In 2018, we published our Human Rights Policy and Labor Practices, which is aligned with the UN Guiding Principles on Business and Human Rights. The principles in the Policy have been integrated into our new Employee Code of Conduct, and we have launched a human rights due diligence process, to assess existing or potential risks across our operations. Governance-Sustainability Council, Our Sustainability Target for 2020, Responding to our materiality assessment, Working to achieve ASI certification, Committing to responsible purchasing, and our Code of Conduct: https://www.constellium.com/sustainability/downloads/policies-codes-conduct
Principle 4: the elimination of all forms of forced and compulsory labour;	22, 36, 38-39, 49, 50	
Principle 5: the effective abolition of child labour		
Principle 6: the elimination of discrimination in respect of employment and occupation.		
ENVIRONMENT		
Principle 7: Businesses should support a precautionary approach to environmental challenges;	22, 36	Our EHS Policy: https://www.constellium.com/sites/default/files/Sustainability/ehspolicy2016-eng_1.pdf Our Code of Conduct: https://www.constellium.com/sustainability/downloads/policies-codes-conduct
Principle 8: undertake initiatives to promote greater environmental responsibility;	41, 47, 48, 51	Minimizing landfill waste, and Boosting our energy efficiency
Principle 9: encourage the development and diffusion of environmentally friendly technologies.	24-26, 30, 42	Packaging, and Increasing recycling rates
ANTI-CORRUPTION		
Principle 10: Businesses should work against corruption in all its forms, including extortion and bribery.	38-39, 50	Responding to our materiality assessment, Committing to responsible purchasing, Our Code of Conduct: https://www.constellium.com/sustainability/downloads/policies-codes-conduct

ALUMINIUM BEVERAGE CAN RECYCLING RATES

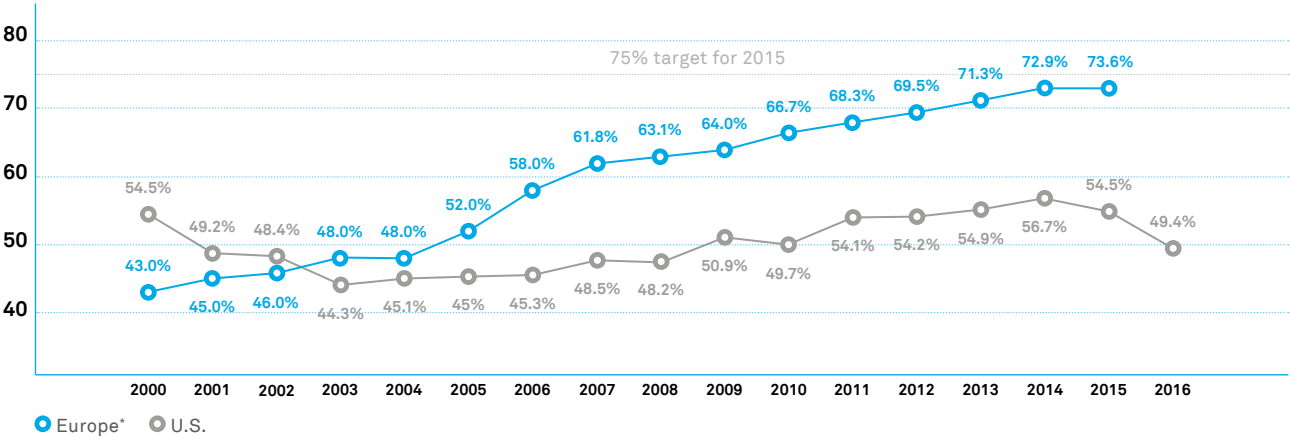

* This is the most recent data for Europe. Figures for this data-point take a long time to process and 2015 data was made available only by 2018. Since 2000, the beverage can recycling rate has seen tremendous improvement, from 43% (in 2000) to 73.6% (in 2015).

RECORDABLE CASE RATE* Pages 18 and 44 for more information about serious injuries

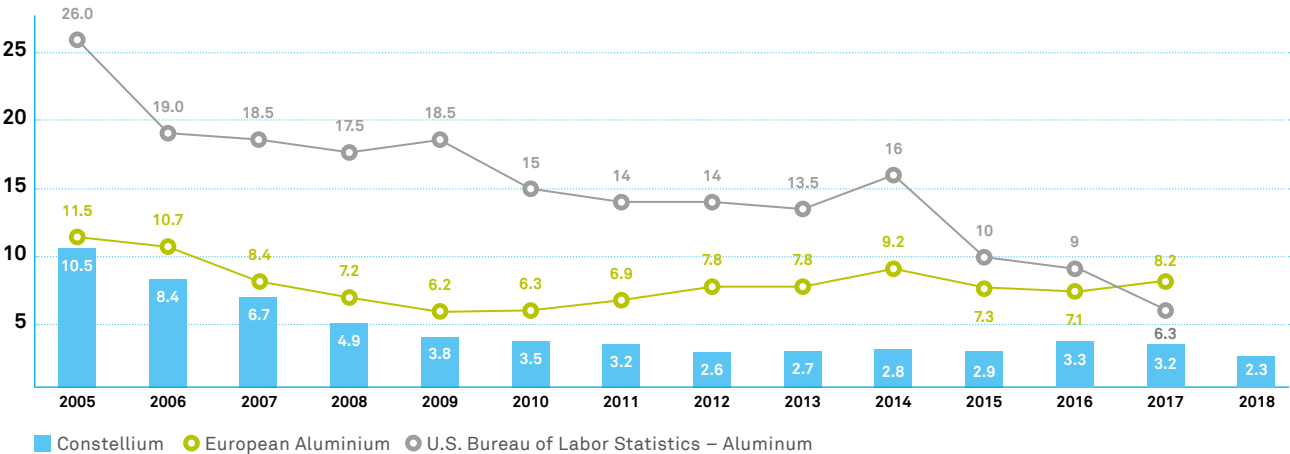

* Recordable Case Rate measures the number of fatalities, serious injuries, lost-time injuries, restricted work injuries, or medical treatments per one million hours worked. Project contractors and visitors have been systematically included in these statistics since 2008. Before that, only extended contractors such as canteen and security staff were included.

GRI 102-8 INFORMATION ON EMPLOYEES AND OTHER WORKERS

		Apprentice	Inactive	Permanent	Fixed-term	Temporary (agency, excluding contractors)
ALL CONSTELLIUM						
Number of employees with specific employment type	Male	231	21	54		
	Female	42	8	16		1
Number of employees per employment contract	Male	-	-	9,682	645	
	Female	-	-	1,317	134	848
Number of employees working full/part-time	Full-time	273	27	10,859	743	
	Part-time	0	2	210	36	849
Total						12,999
Total permanent and fixed terms						11,848
EUROPE						
Number of employees with specific employment type	Male	228	4			
	Female	41	6			
Number of employees per employment contract	Male			7,043	305	
	Female			868	62	786
Number of employees working full/part-time	Full-time	269	10	7,701	362	
	Part-time	0	0	210	5	786
Total						9,343
Total permanent and fixed terms						8,278
ASIA						
Number of employees with specific employment type	Male	-	0			
	Female	-				
Number of employees per employment contract	Male			10	315	
	Female			12	49	1
Number of employees working full/part-time	Full-time	-	0	22	333	
	Part-time	-			31	1
Total						387
Total permanent and fixed terms						386
NORTH AMERICA (UNITED STATES, CANADA & MEXICO)						
Number of employees with specific employment type	Male	3	17	54		
	Female	1	2	16		1
Number of employees per employment contract	Male	-		2,629	25	
	Female	-		437	23	61
Number of employees working full/part-time	Full-time	4	19	3,136	48	
	Part-time	-				62
Total						3,269
Total permanent and fixed terms						3,184

GRI 401-1 NEW EMPLOYEE HIRES AND EMPLOYEE TURNOVER

Apprentices and temporary fixed-term contract employees have been excluded, for accuracy in turnover rate calculation

Employee category	Number of new employees hired in 2018		Number of employees who left the Company in 2018		Number of employees on December 31, 2018		Turnover rate	
	Female	Male	Female	Male	Female	Male	Female	Male
ALL CONSTELLIUM								
Under 30 years old	116	499	92	319	252	1,569	36.51%	20.33%
30-50 years old	186	664	142	394	849	5,449	16.73%	7.23%
Over 50 years old	38	117	58	322	374	3,384	15.51%	9.52%
Total	340	1,280	292	1,035	1,475	10,402	19.80%	9.95%
EUROPE								
Under 30 years old	51	259	10	104	147	1,061	6.80%	9.80%
30-50 years old	73	297	29	162	551	3,866	5.26%	4.19%
Over 50 years old	3	41	21	193	238	2,425	8.82%	7.96%
Total	127	597	60	459	936	7,352	6.41%	6.24%
NORTH AMERICA								
Under 30 years old	62	165	80	145	95	387	84.21%	37.47%
30-50 years old	99	244	109	182	251	1,385	43.43%	13.14%
Over 50 years old	35	75	37	128	132	953	28.03%	13.43%
Total	196	484	226	455	478	2,725	47.28%	16.70%
ASIA								
Under 30 years old	3	75	2	70	10	121	20.00%	57.85%
30-50 years old	14	123	4	50	47	198	8.51%	25.25%
Over 50 years old	0	1	0	1	4	6	0.00%	16.67%
Total	17	199	6	121	61	325	9.84%	37.23%

GRI 404-1 AVERAGE HOURS OF TRAINING PER YEAR PER EMPLOYEE

	Female	Male	Managers*	Operators*	Total employees
Average training hours/year/employee	23.1	20.6	22.7	20.5	20.9

* "Operators" refers to employees working on the shop floors; "managers" refers to employees with administrative or managerial roles.

GRI 405-1 DIVERSITY OF GOVERNANCE BODIES AND EMPLOYEES

BOARD MEMBERS	Female	Male	Total	Age %
Under 30 years old	0	0	0	0%
30-50 years old	1	0	1	9%
Over 50 years old	2	8	10	91%
Total	3	8	11	100%
Gender %	27%	73%	100%	

ALL CONSTELLIUM		Age ranges	Female	Male	Total	Age %	% Female	% Male
Executive Committee Members		Under 30 years old	0	0	0	0%		
		30 - 50 years old	1	2	3	33%		
		Over 50 years old	0	6	6	67%		
		Subtotal	1	8	9		11%	89%
Vice Presidents & Directors		Under 30 years old	0	0	0	0%		
		30 - 50 years old	11	56	67	53%		
		Over 50 years old	6	53	59	47%		
		Subtotal	17	109	126		13%	87%
Senior Managers / Senior Experts / Individual Contributors / Technical Master Experts		Under 30 years old	91	195	286	14%		
		30 - 50 years old	292	923	1,215	57%		
		Over 50 years old	79	534	613	29%		
		Subtotal	462	1,652	2,114		22%	78%
Technicians & Operators		Under 30 years old	161	1,369	1,530	16%		
		30 - 50 years old	546	4,474	5,020	52%		
		Over 50 years old	289	2,791	3,080	32%		
		Subtotal	965	8,333	9,298		10%	90%
Total			1,476	10,403	11,479		12%	88%

GRI 405-2 RATIO OF BASIC SALARY AND REMUNERATION OF WOMEN AND MEN

GLOBAL CONSTELLIUM	Ratio Women to Men
Vice Presidents / Senior Directors	93%
Senior Managers / Senior Experts / Individual Contributors / Technical Master Experts	82%
Technicians & Operators	86%
EUROPE	Ratio Women to Men
Vice Presidents / Senior Directors	89%
Senior Managers / Senior Experts / Individual Contributors / Technical Master Experts	83%
Technicians & Operators	87%
NORTH AMERICA	Ratio Women to Men
Vice Presidents / Senior Directors	102%
Senior Managers / Senior Experts / Individual Contributors / Technical Master Experts	80%
Technicians & Operators	79%
ASIA	Ratio Women to Men
Vice Presidents / Senior Directors	150%
Senior Managers / Senior Experts / Individual Contributors / Technical Master Experts	84%
Technicians & Operators	95%

GRI 302-1 ENERGY CONSUMPTION WITHIN THE ORGANIZATION IN TERAJOULE (TJ)

		2015	2016	2017	2018
Direct energy consumption (TJ)					
	Anthracite	500	522	389	408
	LPG	15	15	15	14
Non-renewable sources	Nat. Gas	13,274	13,198	13,512	13,495
	Diesel	120	118	116	115
	Heavy fuel	163	154	152	155
Renewable sources		0	0	0	0
Total		14,071	14,008	14,185	14,187
Indirect energy (TJ)					
Electricity	Purchased	5,583	5,777	5,938	5,870
	Sold	0	0	0	0
Steam	Purchased	0	0	0	0
	Sold	112	194	104	120
Total Direct + Indirect energy consumption		19,543	19,591	20,019	19,937

FROM ENERGY CONSUMPTION TO ENERGY EFFICIENCY

Raw energy consumption per metric ton is not necessarily the most relevant indicator of energy efficiency, because we need to take into account the effect of different product mixes. For instance, the manufacture of automotive sheet requires significantly more energy during rolling and finishing operations than beverage can body sheet. Therefore, increasing the share of one product over

another will affect the overall energy per metric ton, independently of any other change. For this reason, we correct our energy efficiency indicator to avoid any bias. We have identified the relative energy consumption per metric ton of different product lines and use this to transpose raw data on energy per metric ton into an energy efficiency index. This index thus reflects the intrinsic

manufacturing performance of our operations, regardless of any changes in our product mix. At the same time, we also rely on life cycle assessments to make sure that we manufacture environmentally sound products. We are particularly keen to ensure that products requiring greater energy during production deliver greater energy savings during their lifetime.

GRI 303-3 TOTAL WATER WITHDRAWAL IN MILLION CUBIC METERS

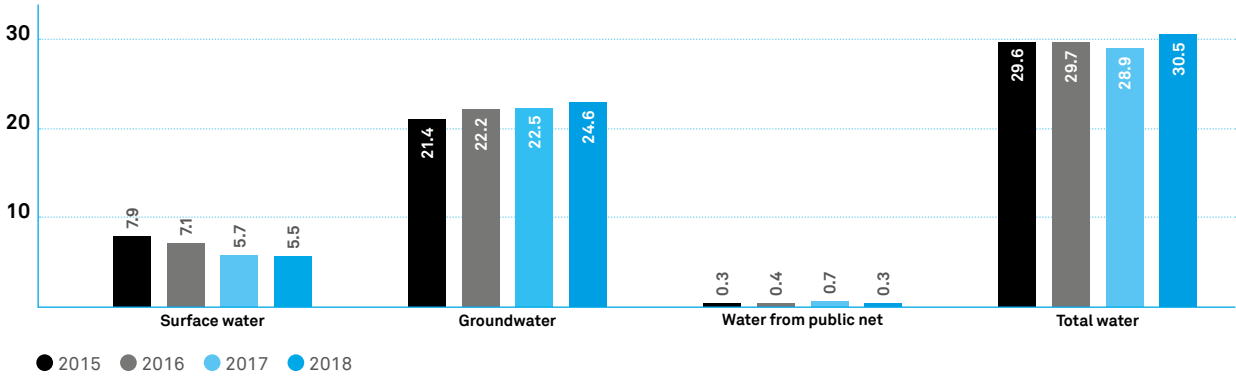

GRI 305-7 AIR EMISSIONS IN METRIC TONS

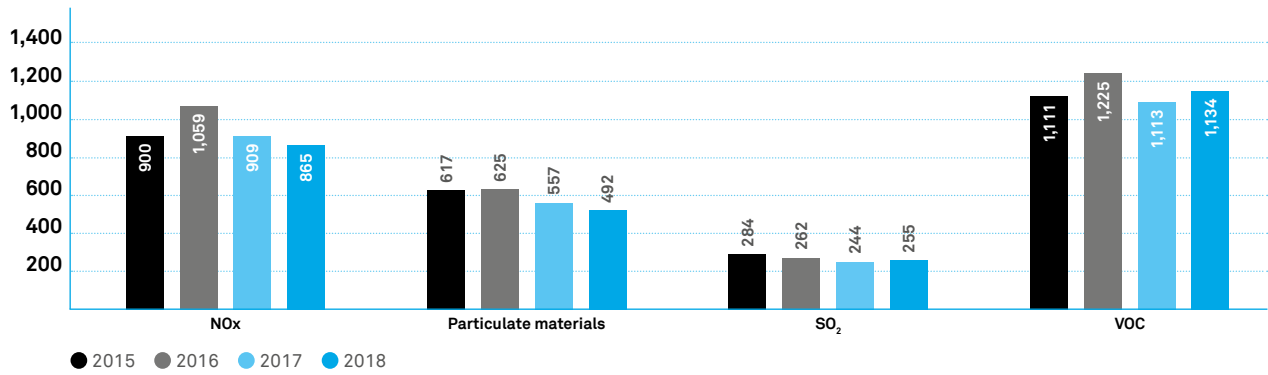

GREENHOUSE GAS (GHG) EMISSIONS See page 51

GRI 306-1 WATER DISCHARGE BY QUALITY AND DESTINATION IN METRIC TONS

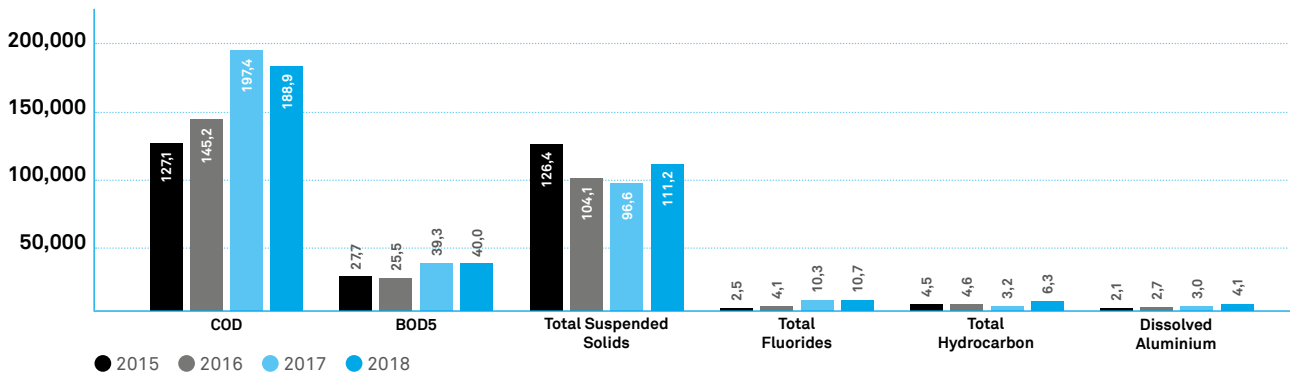

GRI 306-2 WASTE BY TYPE AND DISPOSAL METHOD IN METRIC TONS

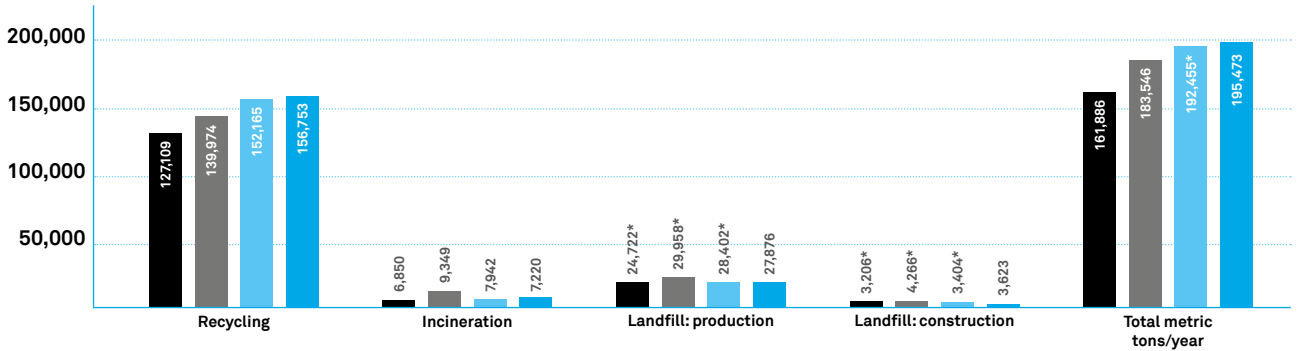

● 2015 ● 2016 ● 2017 ● 2018

* Compared with previously reported data, the balance between production and construction landfill waste since 2015 was amended following improved monitoring of landfill waste. Additionally, 2017 landfill waste data had to be reassessed to account for missing contributions identified since then.

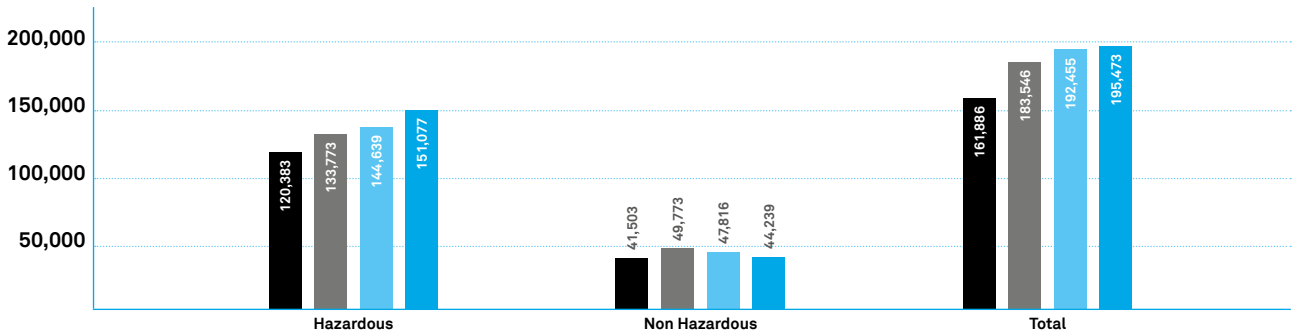

● 2015 ● 2016 ● 2017 ● 2018

Hazardous/non-hazardous definition based on EU regulations.

RESPONSIBLE BUSINESS

Pages 49-50 for more information on Responsible Business

CODE OF CONDUCT TRAINING

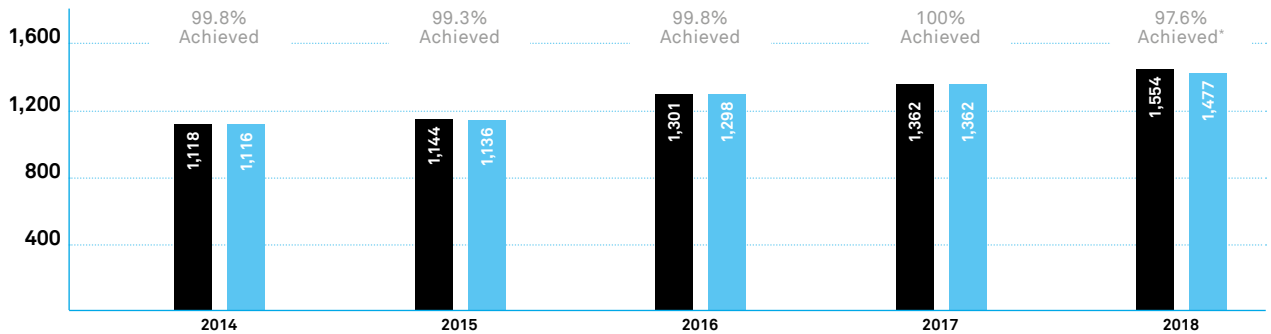

● Number of people targeted ● Number of people achieved

* In 2018 we had 40 exceptional cases, the reasons including maternity and sick leave, retirement, and long-term disability.

GRI CONTENT INDEX

This report has been prepared in accordance with the GRI Standards: Core option

Description	Cross reference/Additional information	Pages	
GRI 102 GENERAL DISCLOSURE			
ORGANIZATIONAL PROFILE			
102-1	Name of the organization	Constellium N.V. (Constellium)	
102-2	Activities, brands, products, and services	A global sector leader Creating value throughout the life cycle of aluminium Our main brands are: Airware®, Sealium, Alumold®, Unidal, Herkal, HK34, Xtral 728, Diamal R, Diamal S, Alplan, Certal, Fortal, Alcast, Fibral, Surfalex®, Formalex®, Strongalex®, Ultralex®, Skybright®, Inoxal®, Solar Surface®, Longlinefinish®, Securalex®, Constellium HSA6™, Constellium HCA6™, Modalex™, Butlerfinish®, Staybright™, Keikor®, Aeral™, Dokima®, KoolX™, @bright™ and Gripster	2-9 12-13 16, 24-34
102-3	Location of headquarters	Schiphol-Rijk, The Netherlands	
102-4	Location of operations	A global sector leader	16, 27, 29, 31
102-5	Ownership and legal form	Constellium is a public company that aims to operate with the highest ethical standards and best practices, to be responsive to our shareholders and other stakeholders, and operates under a worldwide Code of Conduct. We are listed on NYSE under the ticker symbol 'CSTM'. Shareholders as of March 8, 2019 – free float: 87.9%; Bpifrance: 12.1%	
102-6	Markets served	A global sector leader	16, 27, 29, 31 24-34
102-7	Scale of the organization	A global sector leader Unlocking value	16 17
102-8	Information on employees and other workers	Sustainability performance	59-61
102-9	Supply chain	Creating value throughout the life cycle of aluminium	12-13
102-10	Significant changes to the organization and its supply chain	No significant changes	Flap
102-11	Precautionary Principle or approach	Our 2020 sustainability targets: overview Constellium Code of Conduct: https://www.constellium.com/sustainability/downloads/policies-codes-conduct	36
102-12	External initiatives	We are a signatory of the United Nations Global Compact. CEO Interview European Aluminium; Every Can Counts; Aluminium Stewardship Initiative; GRI	15, 57 14-15 37, 42, 49
102-13	Membership in associations	Memberships	71
STRATEGY			
102-14	Statement from senior decision-maker	CEO Interview	14-15
102-15	Key impacts, risks, and opportunities	Governance-Sustainability Council Our Sustainability Targets for 2020 Responding to our materiality assessment	22 36 38-39
ETHICS AND INTEGRITY			
102-16	Values, principles, standards, and norms of behavior	Governance, Engaging our people (MOMENTUM) Working to achieve ASI certification Committing to responsible purchasing UNGC membership We have developed a new Code of Conduct integrating the principles of our Human Rights Policy & Labor Practices.	19-22 45 49 50 15, 57

	Description	Cross reference/Additional information	Pages
GOVERNANCE			
102-18	Governance structure	Governance	19-22
STAKEHOLDER ENGAGEMENT			
102-40	List of stakeholder groups	Governance, Responding to our materiality assessment Memberships	19-22 38-39 71
102-41	Collective bargaining agreements	A vast majority of non-U.S. employees and approximately 50% of U.S. employees are covered by collective bargaining agreements	
102-42	Identifying and selecting stakeholders	Governance Responding to our materiality assessment	19-22 38-39
102-43	Approach to stakeholder engagement	Governance Responding to our materiality assessment Ensuring customer satisfaction Working to achieve ASI certification	22 38-39 43 49
102-44	Key topics and concerns raised	Governance Our Sustainability Target for 2020 Responding to our materiality assessment	19-22 36 38-39
REPORTING PRACTICE			
102-45	Entities included in the consolidated financial statements	All entities owned by Constellium and all operating joint ventures controlled by Constellium during reporting year 2018. This includes all sites mentioned on pages 16, 27, 29 and 31.	16, 27, 29, 31
102-46	Defining report content and topic boundaries	Responding to our materiality assessment In 2017, we renewed and broadened our previous materiality assessment performed in 2014 to identify the issues that matter most to Constellium and our stakeholders. Our sustainability targets are aligned with this vision. See pages 38-39 of our 2017 Business and Sustainability Performance Report for more information, available at https://www.constellium.com/sites/default/files/constellium_business_and_sustainability_report_2017-200718.pdf	38-39
102-47	List of material topics	Responding to our materiality assessment	38-39
102-48	Restatements of information	GRI 306-2 Waste by type and disposal method in metric tons. Compared to previously reported data, the balance between production and construction landfill waste since 2015 was amended following improved monitoring of landfill waste. Additionally, 2017 landfill waste data had to be reassessed to account for missing contributions identified since then.	64
102-49	Changes in reporting	None	
102-50	Reporting period	About this report	Flap
102-51	Date of most recent report	Issued in 2018. Available on our website's sustainability section at https://www.constellium.com/sites/default/files/constellium_business_and_sustainability_report_2017-200718.pdf	
102-52	Reporting cycle	About this report	Flap
102-53	Contact point for questions regarding the report	About this report	Flap
102-54	Claims of reporting in accordance with the GRI Standards	This report has been prepared in accordance with the GRI Standards: Core option	
102-55	GRI content index	GRI content index	65-70
102-56	External assurance	This report is not externally assured	
GRI 103 MANAGEMENT APPROACH			
103-1	Explanation of the material topic and its boundary	Responding to our materiality assessment In 2017, we renewed and broadened our previous materiality assessment performed in 2014 to identify the issues that matter most to Constellium and our stakeholders. Our sustainability targets are aligned with this vision. See pages 38-39 of our 2017 Business and Sustainability Performance Report for more information, available at https://www.constellium.com/sites/default/files/constellium_business_and_sustainability_report_2017-200718.pdf	38-39

	Description	Cross reference/Additional information	Pages
103-2	The management approach and its components	Governance Our Sustainability Target for 2020	19-22 36
103-3	Evaluation of the management approach	Governance Responding to our materiality assessment	19 38-39
GRI 205 ANTI-CORRUPTION			
205-1	Operations assessed for risks related to corruption	Responding to our materiality assessment Our Internal Control and Legal Department carried out a fraud and corruption risk assessment in 2018 using an in-house questionnaire administered at key sites as well as cases reported via the Integrity hotline and Internal Control Reporting network.	38
205-2	Communication and training on anti-corruption policies and procedures	Responding to our materiality assessment We communicate and train our Executive Committee and employees on anti-corruption through our Code of Conduct (CoC) training. Please refer to “sustainability performance” for our CoC training rate. A special session on anti-corruption with the Executive Committee was conducted in April 2019. Training sessions were conducted with our sales and purchasing departments at the sites in France, China, Japan, Singapore and China. The finance teams in China, Switzerland, France, Germany, and the U.S. were also trained. Our internal audit and site-level SOx champions have been trained as well. We have included anti-corruption principles in our Supplier Code of Conduct for our business partners, and clauses in contracts with our customers. We have also put a due diligence process in place for business partners.	38
205-3	Confirmed incidents of corruption and actions taken	None recorded during the reporting year.	
GRI 301 MATERIALS			
301-2	Recycled input materials used	We do not consider the recycled content of aluminium in our products as a relevant metric for measuring the sustainability of performance.	
GRI 302 ENERGY			
302-1	Energy consumption within the organization	Sustainability performance	62
302-3	Energy intensity	Energy efficiency metrics are disclosed on page 48 and in the Energy Efficiency section of the Sustainability Performance section. The principle of metrics is explained in the Energy Performance section.	48, 62 62
302-4	Reduction of energy consumption	a. Total energy savings: 967 TJ since 2015 b. Savings by energy source: fossil fuels 550 TJ; Electricity 417 TJ c. Baseline year is 2015 d. An internal calculation tool is used to assess the energy that would have been used in the corresponding year by applying the 2015 energy/t ratio of each production unit and, where necessary, applying a correction factor to account for changes in the product mix.	
302-5	Reductions in energy requirements of products and services	In automotive and aerospace applications, we account for the reduction in the energy requirement of our products through the mass savings afforded by our aluminium products compared with reference material, such as steel in automotive or previous generations of aluminium alloys in aerospace. An estimate based on life cycle assessment calculations led to savings of over 26,000 TJ for products delivered in 2018, during their lifetime. We based our assumption on an estimate of mass saved in automotive and aerospace applications, and used data from our Life Cycle Assessment tool, following the ISO 14040-44 standard. We plan to complete this assessment in the future with a more comprehensive coverage of our product range.	

Description	Cross reference/Additional information	Pages
GRI 303 WATER AND EFFLUENTS		
303-1 Interactions with water as a shared resource	<p>a. Use of water is mainly concentrated on cooling operations during metal casting (mostly) and rolling activity. Use of water is needed across the value chain (upstream for alumina refining, aluminium casting after smelting, and electricity production, and downstream for finishing operations).</p> <p>b. Use of water is handled within the scope of our ISO 14001 certifications. We also check the status of water risks every year using the online Aqueduct tool.</p> <p>c. We request our key suppliers to be assessed regarding their sustainability performance, including water-related issues. Water is also included in the scope of audits performed of suppliers considered at higher-risk. Our aim is for all our key and higher-risk suppliers to be assessed by 2020. Along with other partners of the aluminium value chain, we committed to the Aluminium Stewardship Initiative (ASI), which created a standard for responsible aluminium that explicitly includes water management. We are working to have our sites certified.</p> <p>d. There is currently no specific water-related goal. We rely on local environmental management to handle water-related topics as a function of local conditions (water availability and quality). We work with local stakeholders and comply with local regulations.</p>	
303-2 Management of water discharge-related impacts	Water discharge management is done according to local regulations and our own water management policy, and included in the ISO 14001 certification scope of our plants.	
303-3 Water withdrawal	<p>a. Sustainability performance</p> <p>b. Water withdrawal from areas with water stress was 15.9 megaliters</p> <p>c. All displayed numbers relate to fresh water. No "other water" source used.</p> <p>d. No assumptions used, data collected from sites' environmental management and consolidated in central database.</p>	63
303-4 Water discharge	Sustainability performance	63
GRI 305 EMISSIONS		
305-6 305-1 Direct (Scope 1) GHG emissions	Addressing greenhouse gas emissions	51
305-2 Energy indirect (Scope 2) GHG emissions	Addressing greenhouse gas emissions	51
305-5 Reduction of GHG emissions	Addressing greenhouse gas emissions	51
305-6 Emissions of ozone-depleting substances (ODS)	None recorded during the reporting year	63
305-7 Nitrogen oxides (NOx), sulfur oxides (SOx), and other significant air emissions	Sustainability performance	63
GRI 306 EFFLUENTS AND WASTE		
306-1 Water discharge by quality and destination	Sustainability performance	63
306-2 Waste by type and disposal method	Sustainability performance	63
306-3 Significant spills	No significant spills recorded in the reporting year	
GRI 307 ENVIRONMENTAL COMPLIANCE		
307-1 Non-compliance with environmental laws and regulations	Significant fines and non-monetary sanctions for non-compliance with environmental laws and/or regulations: none recorded during the reporting year.	
GRI 308 SUPPLIER ENVIRONMENTAL ASSESSMENT		
308-1 New suppliers that were screened using environmental criteria	Committing to responsible purchasing	50
GRI 401 EMPLOYMENT		
401-1 New employee hires and employee turnover	Sustainability performance	60
401-2 Benefits provided to full-time employees that are not provided to temporary or part-time employees	Part-time workers have pro-rata benefits of full-time employees; temporary workers are not eligible for the same benefits. Some selected benefits related to health insurance are granted depending on seniority.	

	Description	Cross reference/Additional information	Pages
GRI 402 LABOR MANAGEMENT RELATIONS			
402-1	Minimum notice periods regarding operational changes	The minimum notice period varies according to the country of operation and is based on local regulations. We follow the rules of the country in question.	
GRI 403 OCCUPATIONAL HEALTH AND SAFETY			
403-1	Occupational health and safety management system	Environment, health and safety Focusing our efforts on safety	18 44
403-2	Hazard identification, risk assessment, and incident investigation	Environment, health and safety Focusing our efforts on safety	18 44
403-3	Occupational health services	Environment, health and safety	18
403-4	Worker participation, consultation, and communication on occupational health and safety	100% of our sites have workforce representation in health and safety committees	
403-5	Worker training on occupational health and safety	Environment, health and safety Focusing our efforts on safety	18 44
403-6	Promotion of worker health	Environment, health and safety	18
403-7	Prevention and mitigation of occupational health and safety impacts directly linked by business relationships	Environment, health and safety Focusing our efforts on safety	18 44
403-8	Workers covered by an occupational health and safety management system	Environment, health and safety Focusing our efforts on safety	18 44
403-9	Work-related injuries	Environment, health and safety Focusing our efforts on safety	18 44
GRI 404 TRAINING AND EDUCATION			
404-1	Average hours of training per year per employee	Sustainability performance	60
404-3	Percentage of employees receiving regular performance and career development reviews	Our professional grade employees receive annual performance and career development through the global HR platform, SuccessFactors. This has been extended to some supervisory levels in France. All other employees receive an annual performance review but this is done on a site-by-site basis and tracked centrally for all managers.	
GRI 405 DIVERSITY AND EQUAL OPPORTUNITY			
405-1	Diversity of governance bodies and employees	Sustainability performance	60-61
405-2	Ratio of basic salary and remuneration of women to men	Sustainability performance	61
GRI 406 NON-DISCRIMINATION			
406-1	Incidents of discrimination and corrective actions taken	No discrimination cases recorded by our integrity hotline during the reporting period	
GRI 407 FREEDOM OF ASSOCIATION AND COLLECTIVE BARGAINING			
407-1	Operations and suppliers in which the right to freedom of association and collective bargaining may be at risk	Our Human Rights & Labor Practices policy includes this essential right and is implemented through our Code of Conduct. Committing to responsible purchasing	38 50
GRI 408 CHILD LABOR			
408-1	Operations and suppliers at significant risk for incidents of child labor	Our Human Rights & Labor Practices policy includes this essential right and is implemented through our Code of Conduct. Committing to responsible purchasing	38 50
GRI 409 FORCED OR COMPULSORY LABOR			
409-1	Operations and suppliers at significant risk for incidents of forced or compulsory labor	Our Human Rights & Labor Practices policy includes this essential right and is implemented through our Code of Conduct. Committing to responsible purchasing	38 50

	Description	Cross reference/Additional information	Pages
GRI 412 HUMAN RIGHTS ASSESSMENT			
412-1	Operations that have been subject to human rights reviews or impact assessments	Responding to our materiality assessment Committing to responsible purchasing.	38 50
412-2	Employee training on human rights policies or procedures	Responding to our materiality assessment We published Human Rights Policy & Labor Practices in 2018: https://www.constellium.com/sites/default/files/external_-_human_rights_policy_and_labor_practices_final_0.pdf The principles of our Human Rights Policy and Labor Practices have been incorporated into our Code of Conduct. Employees are thus trained on human rights during Code of Conduct training.	38
412-3	Significant investment agreements and contracts that include human rights clauses or that underwent human rights screening	Committing to responsible purchasing Human Rights Principles are explicitly mentioned in our Supplier Code of Conduct, available at www.constellium.com	50
GRI 413 LOCAL COMMUNITIES			
413-1	Operations with local community engagement, impact assessments, and development programs	Strengthening Communities	46
GRI 414 SUPPLIER SOCIAL ASSESSMENT			
414-1	New suppliers that were screened using social criteria	Committing to responsible purchasing	50
414-2	Negative social impacts in the supply chain and actions taken	Committing to responsible purchasing	50
GRI 415 PUBLIC POLICY			
415-1	Political contributions	None – it is our policy not to make any political contributions.	
GRI 416 CUSTOMER HEALTH AND SAFETY			
416-2	Incidents of non-compliance concerning the health and safety impacts of products and services	None recorded during the reporting year	
GRI 417 MARKETING AND LABELING			
417-1	Requirements for product and service information and labeling	<ul style="list-style-type: none"> • Sourcing of raw material: 100% of our products comply with conflict-minerals regulations and Constellium communicates the corresponding information on our website (https://www.constellium.com/sustainability/downloads/disclosure-and-certifications). • Content with substances that might produce an environmental or social impact and safe use of the products and services: 100% of our semi-products (cast, rolled or extruded) are covered by corresponding Manufacturer Safety Data Sheets, available on our website (https://www.constellium.com/sustainability/downloads/material-safety-data-sheets). Constellium also complies with REACH regulation, which covers the majority of our production. • Disposal of products and environmental and social impacts: we communicate, advocate and engage to promote even higher recycling rates for aluminium in all products. See in particular section on products. 	42
417-2	Incidents of non-compliance concerning product and service information and labeling	None recorded during the reporting year	
417-3	Incidents of non-compliance concerning marketing communications	None recorded during the reporting year	
GRI 418 CUSTOMER PRIVACY			
418-1	Substantiated complaints concerning breaches of customer privacy and losses of customer data	None recorded during the reporting year	
GRI 419 SOCIOECONOMIC COMPLIANCE			
419-1	Non-compliance with laws and regulations in the social and economic area	Significant fines and non-monetary sanctions for non-compliance with laws and regulations: none recorded during the reporting year.	

Memberships

Membership	Has positions in governance	Participates in projects and committees
Aluminium Association (AA) Member	Board of Directors, Executive Committee Member	Yes
Aluminium Stewardship Initiative (ASI)	Member of the Standards Committee	Yes
ARPAL, Spain	Member of the Board	No
Aluminium France	Member of the Board	Yes
Association Française des Entreprises Privées (AFEP)	No	Yes
France Industrie	No	No
European Aluminium Foil Association (EAFA)	No	Yes
European Aluminium	Executive Committee Member, Member of the Packaging Group Board and Member of the Automotive & Transportation Group Board	Yes
France Aluminium Recyclage (FAR)	President	Yes
Gesamtverband der Aluminium Industrie (GDA)	Member of the Board	Yes
Groupement des Industries Françaises Aéronautiques et Spatiales (GIFAS)	No	No
La Boîte Boisson (BCME)	No	No
Swiss Aluminium Association (alu.ch)	No	No
Syndicat National des Fabricants de Boîtes, emballages et bouchages Métalliques (SNFBM)	No	Yes
United Nations Global Compact (UNGC)	No	No
Wirtschafts Vereinigung Metalle (WVM)	Member of the Board	Yes
Alupro	Member of the Board	Yes
Metal Packaging Europe (MPE)	No	Yes

Forward-looking statements

This report contains statements that relate to future events and expectations and as such constitute forward-looking statements within the meaning of the Private Securities Litigation Reform Act of 1995.

Forward-looking statements include those statements containing such words as 'expects', 'intends', 'plans', 'scheduled', 'should', 'could', 'will', or other words of similar meaning. All statements that reflect Constellium's expectations, assumptions or projections about the future other than

statements of historical fact are forward-looking statements.

The forward-looking statements contained in this report are subject to a number of known and unknown risks, uncertainties and other factors and are not guarantees of future performance.

These risks and uncertainties include, but are not limited to, those set forth under the heading 'Risk Factors' in our Annual Report on Form 20-F, and described from time to

time in subsequent reports, filed with the U.S. Securities and Exchange Commission.

Constellium disclaims any obligation to update publicly any forward-looking statements, whether in response to new information, future events or otherwise, except as required by applicable law.

ABOUT THIS REPORT

Reporting period

Financial year 2018
(January 1, 2018 to December 31, 2018)

Date of publication

June 2019

Report scope

The data or financials relate to Constellium worldwide falling within the scope of consolidation at December 31, 2018.

Report content

The content of this report is based on our business data and the results of our dialogue with stakeholders, the Global Reporting Initiative Standards: Core option and other sustainability ratings and rankings.

Global Reporting Initiative GRI Standards: Core option

Assurance

This report has been prepared in accordance with the GRI Standards: Core option and maintains code of reporting as advised by GRI. It is not externally assured.

Contact

communications@constellium.com or
sustainability@constellium.com

Coordination: Corporate Communications Department and Sustainability Council.

Design and production: Angie

Credits: ©iStockphoto.com/3DSculptor, ©iStockphoto.com/den-belitsky, ©Hubert Raguét-Constellium, ©iStockphoto.com/nycshooter, ©Constellium/Numix/Le-LoKal, ©iStockphoto.com/Rockfinder, ©shutterstock, ©photoAlquimia, ©Dominique Sarraute, ©AIRBUS 2018 – photo by C.SANTANA, ©Greg Courdier pour Constellium, ©iStock/NiseriN, ©iStock/Mlenny, ©iStock/JohnnyGreig, ©Getty/Emanuel M Schwermer, ©Shutterstock/Ekaterina Kondratova.

Print: Printed on paper from sustainably managed forests.

www.constellium.com

