



EMPOWERED PERFORMANCE

SUSTAINABILITY REPORT

OMAL 2018



www.omal.com



EMPOWERED PERFORMANCE

SUSTAINABILITY REPORT

OMAL 2018

LET'S DO A GOOD JOB

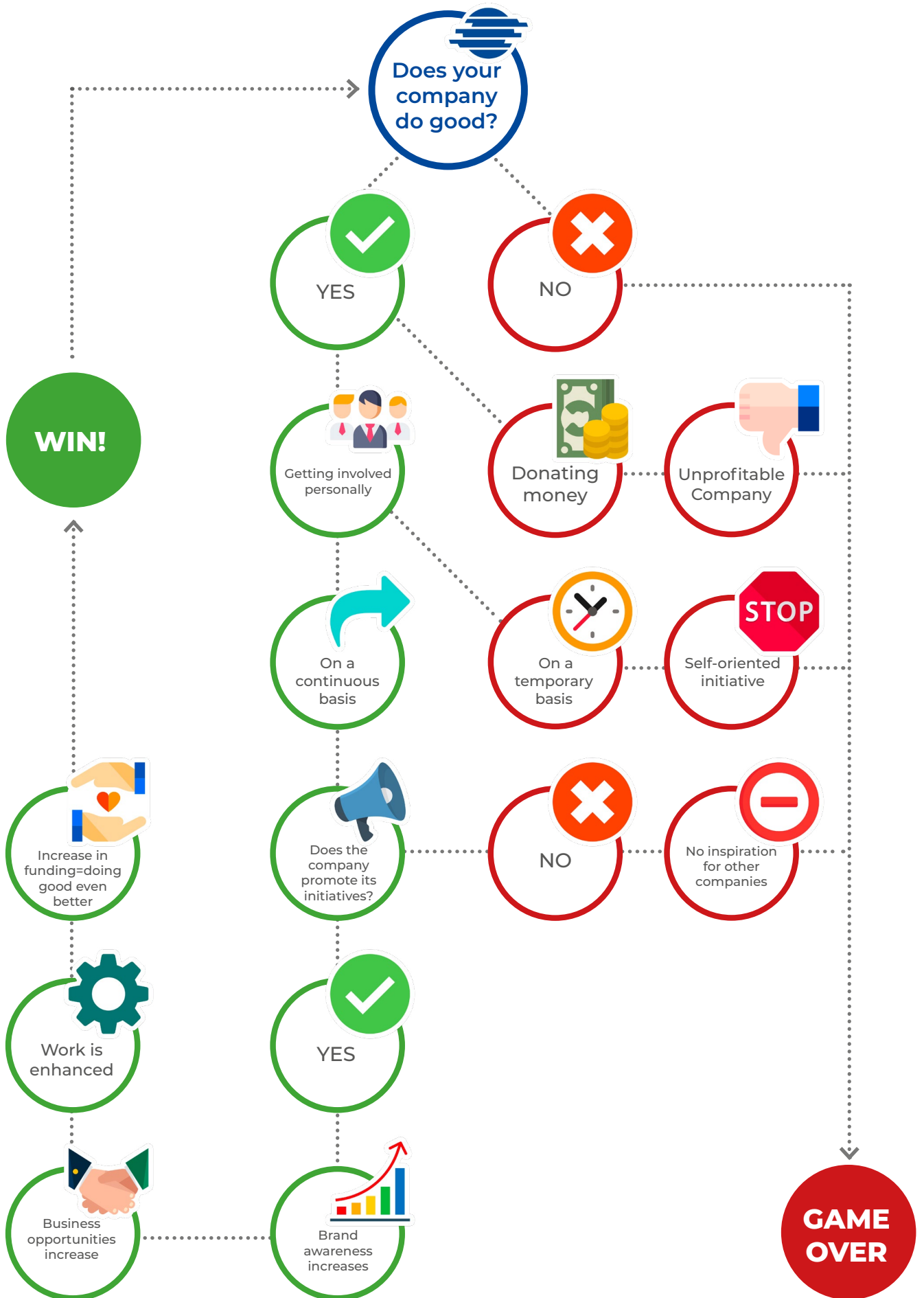

1. INTRODUCTION AND METHOD **7**

| | |
|----------------------------------|----|
| <i>Letter from the CEO</i> | 8 |
| 1.1 Methodology..... | 9 |
| 1.2 Stakeholder mapping..... | 10 |
| 1.3 Stakeholder engagement..... | 13 |
| 1.4 Materiality matrix..... | 14 |

2. THE COMPANY **17**

| | |
|------------------------|----|
| 2.1 Identity..... | 18 |
| 2.2 Products..... | 36 |
| 2.3 Production..... | 46 |
| 2.4 Staff..... | 51 |
| 2.5 Suppliers..... | 55 |
| 2.6 Clients..... | 58 |
| 2.7 Communication..... | 68 |

3. ENVIRONMENT AND QUALITY **77**

| | |
|--|----|
| 3.1 Responsible Quality..... | 78 |
| 3.2 Quality of raw materials..... | 79 |
| 3.3 Respect for the environment..... | 80 |
| 3.4 Distinctions for our commitment in safeguarding the Environment..... | 82 |
| 3.5 GREEN IN..... | 86 |
| 3.6 GREEN US..... | 90 |

4. COMMUNITY AND BUSINESS MODEL **101**

| | |
|--|-----|
| 4.1 The intangible reputation of OMAL Brand..... | 102 |
| 4.2 Virtuous business model..... | 111 |

5. PROSPECTS AND CONCLUSIONS **121**

| | |
|--|-----|
| ● The company, the community and the future..... | 122 |
| ● The company, the environment and the future..... | 123 |
| ● The company, the quality and the future..... | 125 |
| ● Conclusions..... | 126 |

ANNEXES **129**

| | |
|--|-----|
| ● Renewed participation to Global Compact..... | 130 |
| ● Acceptance letter..... | 131 |
| ● Environmental Policy..... | 132 |
| ● Sustainable Procurement Policy..... | 134 |
| ● Internal Targets and Performance..... | 136 |
| ● Compliance with Sustainable Development Goals..... | 138 |
| ● Compliance with Global Compact principles..... | 141 |
| ● Glossary..... | 143 |





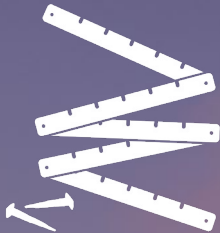

INTRODUCTION AND
METHOD

1

LETTER FROM THE CEO

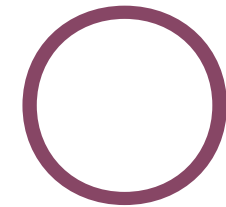

MAL commitment in the 2016-2018 three-year period, the realization of new infrastructures, the boost to technological and organizational innovation, as well as the upgrade of certification schemes for management systems, the search for energy efficiency, the initiatives undertaken in terms of CSR, but also the adhesion to the United Nations Global Compact with the objective of achieving the UN Sustainable Development Goals by the year 2030, (code of ethics, supplier code of conduct, sustainability report, measuring the carbon footprint) have fostered the development of new knowledge and skills, and strengthened our belief that business can be meant as a positive force, able to solve social or environmental problems, so that we can be not one of the best companies in the world but one of the **best for the world**.

We address this report not only as a story of ambition and dedication to share through the many initiatives that we have achieved, but also with the aspiration that our profit-oriented reality, strengthening the workers' sense of belonging, may become a local model of sustainability, that can unite other companies, also from different fields, challenging the diffidence that limits dialogue and collaboration in the market.

We want to share the results obtained in this three-year period, measuring their extent and efficacy, as well as evaluating the level of satisfaction of our stakeholders' expectations.

We want to participate in a network of sustainable companies that share common goals and efforts, together with our stakeholders, by reformulating our business logic on the basis of new "social" expectations to fulfill.

We see the company as an open system, continuously exchanging and communicating with the external world (labor world, families, schools, territory, environment, market, public administration...), that can become an instrument to spread knowledge, boost innovation, safeguard the environment and be the stronghold of collective goods (ensuring the protection of families, by stabilizing jobs and supporting local communities...).

We look at the company as a laboratory to implement sustainable projects ("smart factory" project, adoption of logics of internal chain and creation of chain relations with our suppliers in order to manage inputs and outputs of raw materials according to circular economy criteria, creation of work-related learning programs,...) and to create good practices to be scaled up, through corporate engagement, outside the organization.

Our challenge is to work on social responsibility issues in our territory and plan a sustainability that can meet the needs of the present without compromising the ability of future generations to meet their own needs.

Amedeo Bonomi
CEO OMAL S.p.A.

1.1 METHODOLOGY

The target of OMAL Sustainability Report is to systematize a set of data, procedures, values and goals that can guide the company towards the future. The projects described and measured in this document are the result of our tradition, knowledge and constant search for a continuous improvement of the company.

We believe business sustainability can offer an effective outlook for OMAL internal and external growth projects, and we are sure this will help us to define the best long-term strategy to face the challenges of the market in which we operate.

The company's position is oriented towards a progressive inclusion of sustainability in every business unit, in order to reach coherent and integrated performances, in line with the most virtuous and advanced companies in terms of Corporate Social Responsibility. We are confident that we can represent a responsible and ethical business model, where the social impacts of our work stand alongside profits and respect for the environment. In other words, we believe that – as market actors – we can operate for the good of all our stakeholders, without separating economic and social goals in all our activities.

OMAL commitment in the field of social and environmental sustainability is now in its third year, supported by well-established procedures within corporate functions and prompt and precise communications to external parts. Our awareness originates from a careful reading of the company's values, constantly updated and internally shared in order to conform our Sustainability Report, Code of Ethics, Supplier Code of Conduct and Internal Policies.

The Company has decided to look further into the future, joining international networks for promoting and enhancing Corporate Social and Environmental Responsibility, in particular the United Nations Global Compact, of which this report represents its yearly Communication of Progress. In addition, since 2018 OMAL has been one of the founders of the Global Compact Network Italy, to whom is committed to contribute participating in training and awareness programs and representing a model of coherence with the International Global Impact values.

The data collection process was internally coordinated by OMAL Quality Manager and it has transversely engaged all production units. Similarly, additional data was collected engaging external stakeholders, including clients, distributors, suppliers and institutions of the communities where OMAL operates. Different methods of engagement were implemented for each of them, in order to maximize the diversity of each contribution or opinion gathered. For those local organizations that have benefited from our 2018 Community Volunteering, we created a survey that allowed us to understand how to improve our programs and the level of satisfaction of our partners. The reporting period lasted from January 2018 to December 2018 and involved all OMAL activities and impacts in the production plants of Rodengo Saiano and Passirano, in the province of Brescia.

We therefore renew OMAL path towards growth and its commitment to improve CSR issues and its corporate reputation, that can be considered as a direct consequence of balanced relations between market, people and environment.



1.2 STAKEHOLDER MAPPING

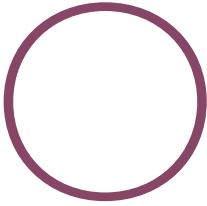

MAL stakeholders were identified by their goals and targets during the engagement process, aimed at establishing stronger and enriching relations with local actors. In particular, in this document we identify as stakeholders those individuals, groups or bodies that can affect or be affected by OMAL activity. Their selection was carried out analyzing the following principles:

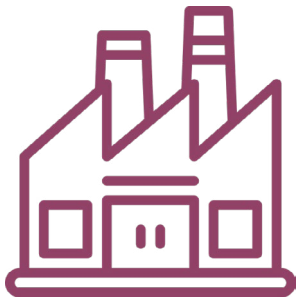

Dependency

With reference to the level of proximity of the stakeholders to the company's economic activities.



Responsibility

With reference to the legal, social, commercial or environmental responsibility that connects the stakeholder to the company.



Urgency

With reference to the need of taking into consideration a particular stakeholder because immediately relevant.

The process of identifying our stakeholders has subsequently led to their mapping, a fundamental step to continue our stakeholders engagement process, that needs different methods and contents according to the kind of stakeholder. The illustration below provides a map of our stakeholders, organized according to their information exchange channels with the company.

OMAL STAKEHOLDERS AND THE MAIN INFORMATION EXCHANGE CHANNELS

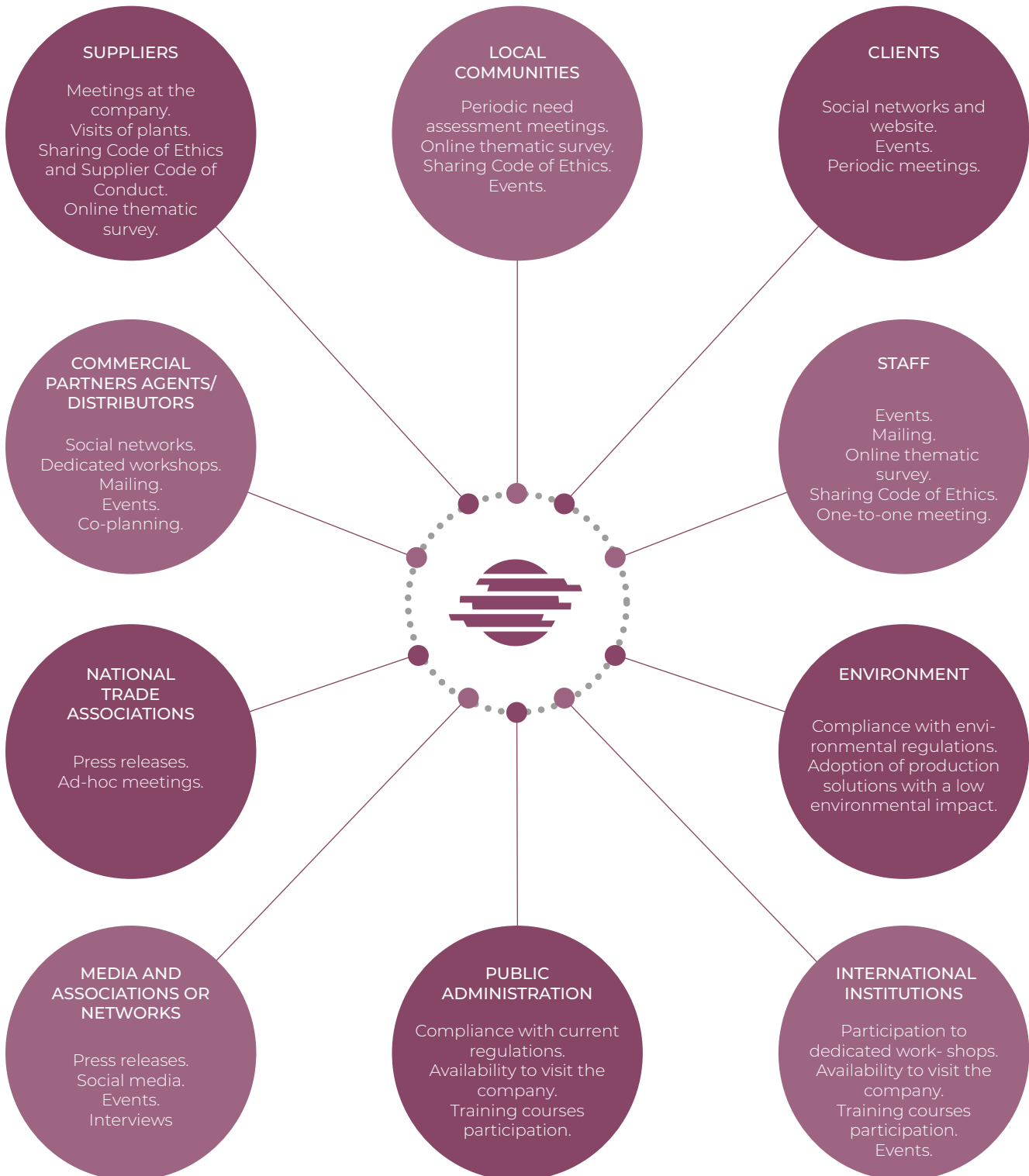

We have subsequently organized our stakeholders according to the nature of their relations with OMAL, depth of the engagement process and kind of communication developed for each one. This process has then led us to a separation for level of engagement, derived from the AAA1000 (2015) standard, as illustrated in the figure below.

LEVEL OF ENGAGEMENT

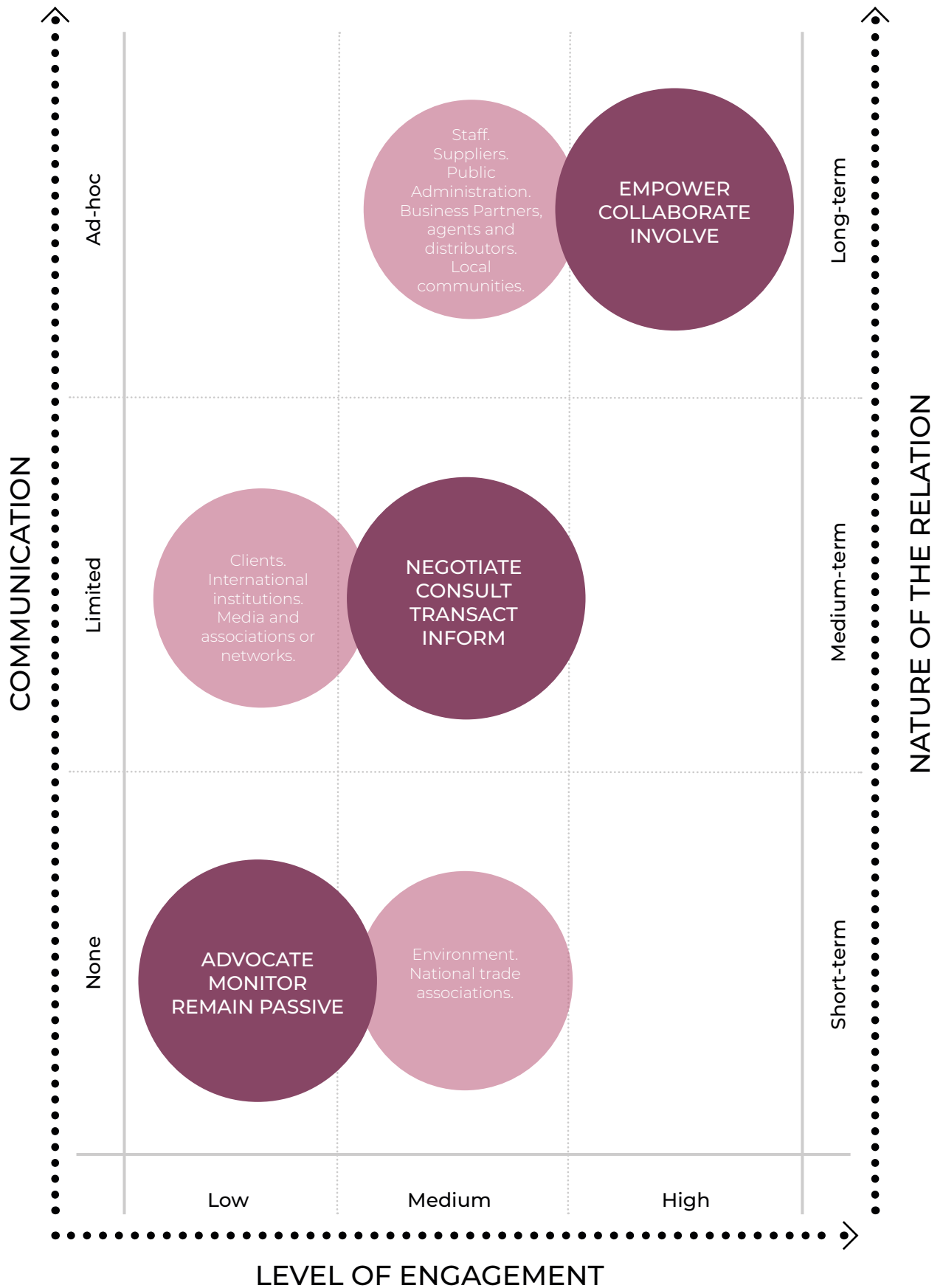

1.3 STAKEHOLDER ENGAGEMENT

Stakeholder engagement is a process where an organization, while elaborating its corporate policies or strategies, engages all those that can affect or be affected by the achievement of the company's goals.

Therefore, it is a question of preparing a dialogue and a systemic and structural engagement of our stakeholders, from understanding their needs to meeting their expectations. This process implies taking into account needs, problems, solutions and suggestions of all OMAL internal and external actors, to obtain a useful strategic convergence for planning and creating long-term social impacts.

Since 2016, OMAL has used several engagement channels with its stakeholders, in order to obtain feedbacks and constructive suggestions. In particular:

- MEDIA
- OMAL WEBSITE
- DOCUMENTS REPORTED BY STAKEHOLDERS
- POLICY PAPERS
- PARTECIPATION TO EVENTS AND CONFERENCES
- WEB SURVEYS
- FOCUS-GROUPS
- AD HOC MEETINGS WITH STAKEHOLDERS FOR SHARED PROJECTS
- MULTI-STAKEHOLDER INITIATIVES



1.4 MATERIALITY MATRIX

In 2016 we started a process to identify the most important subjects to focus our attention and efforts on, in compliance with GRI-G4 guidelines. Such activity has allowed us to define the materiality matrix, namely the instrument that shows how relevant is a specific subject for a company and its stakeholders, and to prioritize our actions and calibrate expectations and timeframes. This methodological instrument has allowed us to define the most important subjects, that have also been influenced by media-analysis, the evaluation of documentation provided by Italian and foreign competitors, OMAL code of ethics and global mega-trends as reported in international documents and policies.

The figure below represents OMAL Materiality Matrix, updated in 2018 as far as concerns the company's priorities. Horizontally it is expressed the importance the company gives to the subjects identified during the stakeholder engagement, while vertically it is expressed the importance given by the stakeholders engaged. OMAL has treated less intensively the subjects reported in the first and second columns because non material, the subjects in the third and fourth column were instead broadly handled both at internal and external level.

Updating the materiality matrix yearly allows the company to focus on minimum importance shifts that could result in new innovative projects and reorganize work scenarios. For instance, data privacy has become one of the less relevant subjects, having OMAL – during last year – completed every necessary step to safeguard data and identity of its stakeholders. On the contrary, the digitalization of processes remains a top priority, in line with the excellence goals that OMAL has envisaged since the beginning of its activities in 1981.



As stated above, the Materiality Matrix represents the framework of all CSR activities within the company and it is therefore functional to the definition of long-term programs, already started by OMAL, as:

- **INTEGRATING SUSTAINABILITY INTO EVERY COMPANY OPERATION**

commitment to integrate elements of Environmental Sustainability into the operations of our Purchasing, Social Innovation/Communication, Sales, Administration, Quality, Technical, IT, Assembly and Production Departments, with lean impacts in managing internal processes.

- **CO-CREATION**

sharing our initiatives with different actors inside or outside OMAL.

- **REPLICABILITY**

scalability of experiences in new territories, with new actors and/or longer timeframes and subsequently broader impacts.

- **RELEVANCE**

highlighting most relevant subjects.

Moreover, for the purposes of this document, we have prepared a summary table that links OMAL projects for 2018 to the Global Compact principles. The same logic was also applied with reference to the Sustainable Development Goals, that provided to OMAL further elements to align its initiatives to the development global scenarios.

| | | | | |
|--|-----------------|---|--|--|
| | | | <ul style="list-style-type: none"> • Use of recycled and recyclable materials. • Gender equality and meritocracy. • Reduction of environmental impacts. • Human resource development. | <ul style="list-style-type: none"> • Brand Reputation. • Legal compliance and transparency in relations. • Product Innovation. • Client satisfaction. • Employment protection. • Risk management and prevention. • Health and Safety. |
| | | | <ul style="list-style-type: none"> • Non-commercial partnerships with local communities. • Process Innovation. • Responsible management of supply chains. • Intergenerational responsibility. • Respect for human rights. | <ul style="list-style-type: none"> • Protection of the company's solidity and profitability. • Integrity and precision in business conduct. |
| | | <ul style="list-style-type: none"> • Obtaining new certifications. • Talent attraction. | <ul style="list-style-type: none"> • Cultural integration. • New markets opportunities. • Company Welfare. • Climate change. • Economic and philanthropic commitment. | <ul style="list-style-type: none"> • Digitalization of all processes. |
| | • Data Privacy. | | <ul style="list-style-type: none"> • Increase in regulatory complexity. | |



VALUES FOR OUR STAKEHOLDERS





THE COMPANY

2

2.1 IDENTITY

..... 1981

OMAL originates from the foresight of Mr. Agostino Bonomi who, as son of a dynasty of entrepreneurs dedicated to ball valves production, decides to establish a new activity in Polaveno in Val Trompia. Unlike other companies that used mass production methods, the founder puts a strong emphasis on the importance of automation and customization for a product that, although it's an industrial component, in the eyes of OMAL owner requires a different design approach. It is therefore created a team of engineers and technicians able to design valves for different kinds of clients and purposes, to satisfy the most complex and technically advanced needs and ensure above-average performances. This strategy of differentiating products rewards OMAL that, in a few years, grows, increases its revenues and gradually opens to foreign markets, starting from Germany.

..... 1987

OMAL moves to Villa Carcina, in Val Trompia, increasing the number of employees and products available to the market.

..... 1992

OMAL, one of the first companies in its field in Brescia, implements and obtains the certification for its Quality Management System, according to ISO 9001 standard (certificate n. 0041/7 of the 14/07/1992).

..... 2008

OMAL opens a new production plant in Rodengo Saiano, Franciacorta, where all operation units currently operate, except for the production and technical departments that in 2016 moved to a new plant in Passirano. For eight years the company has grown, counting on 92 employees divided in the two plants.

..... 2012

OMAL implements and obtains the certification for its Environmental Management System for the Rodengo Saiano plant, according to ISO 14001 standard (certificate of the 23/01/2012).

..... 2016

OMAL builds a new warehouse, where gradually moves the valves and actuators production and design departments, employing almost a hundred workers in total.

2017

OMAL extends the certification for its Environmental Management System also to the Passirano plant, according to ISO 14001 standard, and obtains the B Corp certification.

2018

OMAL renews its web image launching a new official website, a dedicated APP for products and offers and a new institutional video.

Today, OMAL production activities are still entirely in Italy, another important aspect to prove the value that OMAL has always attributed to the Italian ability to design and manufacture mechanical products with a special attention and dedication, in line with its corporate values and following a craftsmanship tradition meant as care for details and flexibility to adapt the product to the client needs. Currently, OMAL operates on a total surface of 38 thousand square meters, 17 thousand of which are roofed.

Passirano plant, OMAL production site.



ECONOMIC AND FINANCIAL DATA

| Amounts in thousands € | 2017 | Incid.% | 2016 | Incid.% | 2015 | Incid.% | 2014 | Incid.% |
|-----------------------------------|---------------|-------------|---------------|-------------|---------------|-------------|---------------|-------------|
| Sales revenues | 29.617 | 100,0% | 27.305 | 100,0% | 28.079 | 100,0% | 27.741 | 100,0% |
| EBITDA | 2.678 | 9,0% | 1.831 | 6,7% | 2.416 | 8,6% | 2.335 | 8,4% |
| EBIT | 1.327 | 4,5% | 533 | 2,0% | 1.138 | 4,1% | 1.251 | 4,5% |
| Pre-tax result | 1.208 | 4,1% | 369 | 1,4% | 1.066 | 3,8% | 1.076 | 3,9% |
| Result for the fiscal year | 861 | 2,9% | 225 | 0,8% | 644 | 2,3% | 646 | 2,3% |
| Current assets | 15.330 | | 15.186 | | 13.954 | | 14.044 | |
| Fixed assets | 5.216 | | 4.518 | | 4.063 | | 3.269 | |
| Total capital employed | 20.546 | | 19.704 | | 18.017 | | 17.313 | |
| Current liabilities | 12.116 | | 11.259 | | 10.207 | | 9.364 | |
| Consolidated liabilities | 4.004 | | 4.877 | | 4.474 | | 4.841 | |
| Net Capital | 4.426 | | 3.568 | | 3.336 | | 3.109 | |
| Total financing funds | 20.546 | | 19.704 | | 18.017 | | 17.313 | |
| Investments | 2.014 | | 1.717 | | 1.887 | | 4.318 | |
| Number of employees | 93 | | 98 | | 92 | | 91 | |
| ROS | 4,48% | | 1,95% | | 4,05% | | 4,51% | |
| ROI | 6,46% | | 2,70% | | 6,32% | | 7,22% | |
| ROE | 19,45% | | 6,31% | | 19,31% | | 20,79% | |

In December 2018, OMAL received the CRIBIS Prime Company, an important award that every year is given only to 3% of over 6 million Italian companies. OMAL reached the highest level in the evaluation of its business and economic reliability and payments to suppliers.

To sustain growth, in 2017 several investments in every company's branches were finalized, even if most of the investments concerned the improvement of company's processes (e.g. purchase of new equipment for mechanical works, automatic machines for assembly and testing, a new management of logistics and new operational tools).

Since 2016, OMAL has been committed to an important investment plan, not only to complete its infrastructures but also to enhance its manufacturing capacity in order to ensure the achievement of the established growth goals.

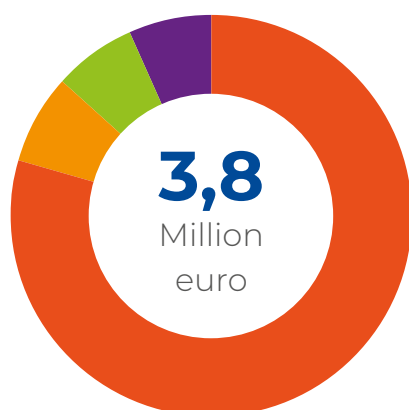

INVESTMENTS

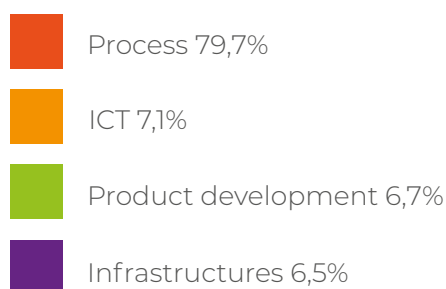

CRIBIS Prime Company Certificate

VALUES

In OMAL, we believe that the identity of a company derives from daily work and the style chosen to face social and economic relations. The company reputation has – so far – been one of the most important aspects of our social and marketing policies, that is the reason why OMAL is committed to keep a high standard of ethical and social engagement. More than words, we believe facts can better describe a company that does not falter and achieves concrete actions, putting words into practice.

OMAL identity path within corporate ethical and social values can be sum up in the following principles:

Passion

For OMAL Passion means not to settle for average results but always try to exceed our performance by constantly improving our products and processes, without forgetting human growth and a motivating work environment, open to dialogue.

“You understand to be in a magical place when you go back home at night and keep thinking about that product you can’t design or that process testing your patience...and you realize that you haven’t brought home your job, but your passion”.

Respect

For OMAL Respect means understanding needs and differences of our interlocutors, whether they are colleagues or business partners, respecting everyone’s position and continuously interfacing to identify common and viable solutions.

“We don’t need internal rules to understand that in everything we do we must respect our role and the dignity of our work, every day, towards everyone”.

Sense of Duty

For OMAL Sense of Duty means ensuring the respect of agreements, promises and ambitions within the established timeframe and with methods shared with our partners. If necessary, the Sense of Duty requires the right flexibility to find brave, original and out of the box solutions.

“We don’t need many words to explain what sense of duty means to us, three are enough: Never give up”.



The abovementioned values are an integral part of **OMAL Code of Ethics**, a crucial strategic document to put the company in the CSR and sustainable business world. Our Code of Ethics, divided in several sections according to the relevant stakeholders, includes a collection of corporate values that any actor interfacing with the company is required to respect. The baseline of any CSR reasoning is the Code of Ethics, that OMAL gives to every new employee as an element for a prosperous work and human relation.

OMAL Code of Ethics

VISION, MISSION AND TRANSPARENCY

In accordance with our three core values, the company vision reaffirms the determination of every OMAL employee and its ownership to work together pursuing “a fair balance between man and environment to improve the quality of life and guarantee a better future for next generations”, so that we can add a further connotation to OMAL work commitment. Such system of values is concretely expressed in the company mission: “We guarantee a better world for our children. Thanks to our products, we safeguard the environment around us and we tangibly improve the quality of life, making our plants safer and more reliable”, in which it is enclosed the essence of OMAL activities, aimed at making the company a landmark for those clients who can recognize a qualitatively superior product, appreciating its technical reliability and long-lasting durability.

VISION AND
MISSION

PASSIONE
PASSION

SENSO DEL DOVERE
SENSE OF DUTY

RISPETTO
RESPECT



In order to send a clear message to anyone entering business relations with OMAL, the company is voluntarily engaged in a process of certification, focused on the **transparency** of its business operations and sponsored by AGCM – the authority for the protection of loyal competition on the market. This process works as a rating system, with a series of questions, and it is addressed to those companies operating in Italy that reached a minimum turnover of two million Euro for the fiscal year prior to the rating request.

The process, successfully concluded in May 2017, allowed OMAL to gain two transparency stars out of three available, that, as stated on the website, identify those companies able to:

- comply with the contents of the Legality Protocol signed between the Ministry of Internal Affairs and Confindustria (the Italian Manufacturer’s Federation) and the relative implementing guidelines, the Protocol signed by the Ministry of Internal Affairs and the League of Cooperatives and, at local level, Prefectures and trade associations;
- use of traceability systems for payments, even for those amounts below the limits provided by law;
- adopt an organizational structure that checks the conformity of company operations with current applicable regulations or an organizational model in compliance with Legislative Decree 231/2001;
- adopt processes to guarantee forms of Corporate Social Responsibility;
- be listed in one of the registers of suppliers, service providers or work executors not subject to organized crime infiltration attempts;
- have entered into self-regulatory codes of ethics adopted by trade associations;
- have adopted organizational models to fight and prevent corruption.



In the event of loss of one of the fundamental requirements needed to obtain a “star”, the Authority revokes the rating. Coherently with the value of transparency protected by the rating itself, AGCM allows the identification of all companies whose ratings were given, suspended or revoked and their effective dates at the following link: <http://www.agcm.it/rating-di-legalita/elenco.html>.

PHILANTHROPY

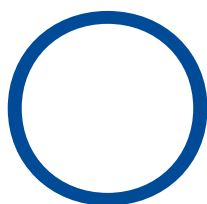

MAL is aware of its social role in Franciacorta and Val Trompia communities, for this reason it conceives its work and commitment within a network of social relations to respect and safeguard. The company therefore listens to local communities and, when possible, meets the needs of local organizations and institutions in order to participate in public welfare and protect disadvantaged people.

Among the several ways the company has historically chosen to help its communities, **philanthropy** has always been an intervention channel to respond to local or national emergencies or to support special sectors, considered particularly important by the ownership, as youth sports and people with disabilities.

Philanthropy does exist in OMAL but is not strategic, as it is not used for marketing or structural purposes, so that it doesn't represent an automatic contribution but a real commitment, motivated by emergency or particularly virtuous situations.

.....

We have opted for a modern approach towards pro bono donations, that should be considered exceptional disbursements, as opposed to a strategy of direct engagement of our employees locally, as outlined below. In 2018, OMAL philanthropic programs worth mentioning were:

A) RUGBY LUMEZZANE

This donation has contributed to the organization and sport management of each category of 15-players rugby (men) teams in Italy. Rugby Lumezzane, in fact, manages all teams between Under 6 and Under 18 years old. Moreover, Lumezzane Rugby has a senior team that in the 2017/2018 B series championship ended the season with a fifth place. In the same year, both the Under 16 and 18 teams reached the finals of their championships, with the chance of competing for the promotion to the Elite championship (the top category league). Lastly, the Under 14 team ended the season with only two defeats and a promising numerous group. Of all the reasons of this success, one of the most important is a complete and qualified technical staff, whose coaches are all certified by the Italian Rugby Federation, and young trainers, Physical Education graduates, who guide the youngest kids. From this care for the professionalism of coaches and trainers starts the initiative "Progetto Motoria", ("Motor Project") entirely planned by the club technical staff. It's an extra training session – for children aged between 5 and 11 years – with the goal of developing psychomotor abilities that young athletes need for their growth, not only in rugby.



RESULTS

The rise of registered members is a consequence of the awareness campaign that the trainers carry out through the “School Project”. Last school year, Rugby Lumezzane visited 60 facilities in Lumezzane and other towns of Val Trompia and Val Sabbia, for a total amount of 1500 hours. Not only the number of club members is rising, but also the geographical origin of the players is expanding. The variety of towns of residence of the players is gradually increasing, with a consolidating number of residents in the towns of the Upper and Mid Val Trompia. In order to help those boys who live in more distant towns, the club has strengthened the transport service during practice days. To provide to the population of the Upper Val Trompia a broader sport offer, another School Project was launched in Bovegno, with the goal, by the end of the school year, to be operative also in nearby towns. The club wants also to organize free practice sessions to boost the knowledge of this discipline, even where historically there wasn't any presence of it.



PROSPECTS

The strength of the numbers in youth teams is becoming a trend that in the medium-term will guarantee a senior team almost entirely self-created. This is one of the main goal of the club. Moreover, from this solid base it will be possible to raise the sport goals of the Mini and Junior Rugby teams, but without betraying the educational principles of the club, including the non-selection of the players and a full acceptance of every athlete. Lastly, the club is persuaded that any increase in its size must always and by all means be sustainable and real. Increasing the internal numbers at all costs will never be a goal, but the search of teaching quality and the dissemination of values of inclusion, respect and equality will always remain the main goals.



B) FLAG FOOTBALL

The company has renewed its commitment to support the educational and sport program Junior Flag Football, for boys and girls aged between 6 and 17 years. The goal of this philanthropic commitment has been double: on the one hand managing the social and inclusion aspects of national championships, on the other supporting the boys and girls national selections that participated to the International Tournament "Seven Lakes" in Varese. Lastly, a residual part of OMAL donations were allocated to the ITALIA Academy team (a selection of the best Under 17 national players of flag football) that participated to the Senior First League 2018, helping mostly kids coming from disadvantaged families, who have consequently been able to show their talent with the federal support. These ethical and learning goals are part of an operational plan set up by the youth flag football Management for 2018.

RESULTS

1) The number of teams in youth championships has increased in the previous years, reaching the record number of 55 teams in 3 categories.

2) The Flag Football Association managed to bring 3 national teams (2 boys team and 1 girls team) in the first 4 places of the Varese Tournament, with a super final between the boys teams.

3) ITALIA Academy, with a roster of 17 kids coming from all over Italy (1/3 of the boys was 16 years old), earned the salvation in the top series senior championships, taking the 8th place (out of 12) and confronting much more expert teams, with an average age of over 24 years.

PROSPECTS

For 2019 the goal is to better develop the MiniFlag category, for kids aged between 6 and 9 years, in order to show and valorize the educational values of flag football for the youngest children through dedicated projects in several schools and so expand our youth sector.



C) ICARO BASKET

OMAL sensibility on the subject of disability and on the role of sport in social integration processes, has allowed ICARO BASKET – a non-profit Amateurs and Volunteers Sport Association – to finalize a number of sport activities dedicated to people with or without disabilities, including the National wheelchair basketball championship and the National tournaments of table tennis and other sports at amateur and recreational level.

OMAL donations have allowed to:

- 1) buy sport equipment for the wheelchair Basket and Table Tennis teams: every athlete needs a customized sport wheelchair that usually costs a lot, moreover OMAL funds cover spare parts and materials costs that are very expensive;
- 2) support and train new athletes to include in the wheelchair Basket team, helping young kids with disabilities to start a sport practice, especially at the early stage, with preparatory activities followed by specialized and certified trainers;
- 3) help growing the “School Project”, facilitating meetings between the athletes of ICARO Basket and more than 5000 students of primary and secondary schools, with the goal of spreading the awareness of wheelchair basketball, by organizing matches between athletes with disabilities and students, to boost a culture of inclusion through sport.

RESULTS

- 1) About 50% of OMAL donations were allocated to the competitive sector to cover the travel expenses of “OMAL Icaro Basket”, that participates to the National FIPIC (Italian Wheelchair Basketball Federation) championship;
- 2) The rest of the money donated by OMAL was allocated to transport the wheelchairs of the youngest athletes during sport matches.

PROSPECTS

“Icaro Sport Disabili Onlus”, a non-profit organization, intends to continue the abovementioned activities in the future, helping more and more kids with disabilities to start a sport practice. The experience shared between OMAL and ICARO has proved how sport is an essential instrument to give people with disabilities autonomy and confidence in their abilities, spreading an important social message.





STRATEGY

In line with everything illustrated above, a precise corporate plan becomes clear, aimed at placing OMAL among the top companies in terms of brand reputation and, obviously, responsible production. OMAL activities therefore shall be interpreted in a broad-based strategy. To give context to global growth targets within OMAL and to put the company inside the reference market, a strategic development plan has been prepared, based on the following guidelines:

“Strategic Plan 2016-2020”, identifying for each operation the following drivers:

1. Organizational
2. Competitive

“Dashboard 2020” defining – for each operation:

1. Critical success factors
2. KPI
3. Safety margins

Corporate training - “In FormAzione” program:

To support our 2020 strategic plan we have defined the following specific training needs, united in the corporate training program called “In FormAzione”:

1. Technical skills: English language, business intelligence, managing system;
2. Managing Skills: Work organization, Leadership skills, Ability to delegate.

The training program “In FormAzione” also establishes an internal training (corporate self-training) to transfer skills and/or support in case of staff changes in key roles, and the “Shake it out” contest, to facilitate and support a continuous innovation within the organization.

Alongside this four-year program, implemented for every single operation, there is a higher strategic level focused on the efficiency of inter-operation and intra-operation processes, in order to advance in a more coordinate and efficient way in increasingly complex projects.

To this end, all unit managers shall be able to: organize, manage and measure goals and results to improve performances on the basis of 6 transversal key points for every operation, as illustrated below:



In greater detail, the 2020 Vision deems necessary to valorize and optimize:

- 1 **Organizational Assets** > definition of what to do and how to do it
- 2 **Human Capital and Training** > definition of who does what and the skills to apply
- 3 **Definition of Risk Situations** > definition of risks connected to strategic organizational decisions
- 4 **Key Performance Indicators** > definition of KPI for every single operation
- 5 **Environment Safeguard** > definition of environmental good practices for every single operation
- 6 **Social Innovation & Communication** > Definition of projects of Social Innovation linked to the core business and the company's image associated to brand reputation.

2. THE COMPANY

In short, with these 6 points we want to develop the same method for each operation, aiming at a continuous improvement supported by a quantitative analysis of performances.

The program includes the following activities:

- Scheduling of project management activities, on a quarterly basis and for each manager;
- Scheduling of managerial meetings “All summoned”;
- Training programs for managers and supervisors;
- Creation of a plan of performance indicators for each operation;
- Planning other team building events for every unit manager.



As far as concern our organizational priorities for the year 2018, the series of meetings “All Summoned” continued on a quarterly basis, to better share the company’s strategy within the organization. Set forth below are the scheduled dates:

Tuesday 03/04/2018
1st quarter Update

Monday 02/07/2018
2nd quarter Update

Monday 08/10/2018
3rd quarter Update

Monday 22/11/2018
2019 Budget Presentation

We also planned capacity building activities to strengthen OMAL/ACTUATECH group’s logics, as well as our Smart Factory project described in the final focus.

About product priorities, last year OMAL launched and started to sell the new Glifo actuator, now available in our sales catalogue.

At last, about training priorities, several training programs were implemented throughout the year (new colleagues’ training, specific training to obtain new qualifications or skills in quality control or design) as described in the “staff” subsection of this chapter.



Ultimately, in the next two years our strategic priorities will be: strengthening the Smart Factory project, Corporate Reputation (described according to social or environmental impacts in chapters 3 and 4) and Corporate Sense of Belonging, put into effect with a set of initiatives in favor of the employees, as further described in this 2018 Sustainability Report.

2018 2020

- SMART FACTORY**
Enhancing the digital efficiency of the company
- CORPORATE**
Enhancing brand reputation
- CORPORATE SENSE OF BELONGING**
Enhancing the engagement of collaborators

FOCUS: SMART FACTORY

The SMART FACTORY project, created with *the objective of digitally permeating the company*, in 2019 will be subject to a further expansion of its application in the following areas:

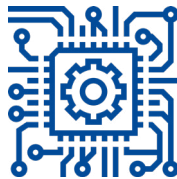

INTELLIGENT ROBOTIZATION

Thanks to the new IoT structure, the project of “intelligent” automation of company processes will continue and it will involve not only the production and assembly departments but also the logistic (smart warehouse project).



BUSINESS INTELLIGENCE

The continuous improvement process is based on this principle: “You can only improve what can be measured”. Therefore it is extremely important the role of user friendly analysis tools, that allow real-time decision making: the market expects quicker answers and this needs an immediate decision-making ability, so we will continue to implement software as JPA, Qlik view, Qlik sense.



OMNICHANNEL DEVELOPMENT

OMAL shall be ready to face the challenge of using different integrated channels to communicate, advertise and sell its products. The new company website launched in 2019 is the answer to this challenge. It features a product configurator, developed for helping clients to choose the right combinations and submit requests, and the OMAL CATALOGUE App, that allows an easy access to all OMAL products information through any connected device.



ZERO PAPER PROJECT

This approach has become a consolidated practice in the company and it is linked to a “Smart Factory” culture, that among the signs of smartness counts environmental awareness. That is why this Sustainability Report includes a chapter dedicated to OMAL commitment to environmental values.



2.2 PRODUCT

DESIGN

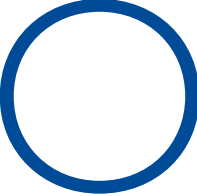
 OMAL interest for advanced and performing production processes, that could distinguish it from its price-oriented competitors, has led the company to include environmental evaluations into the design process, with economic and reputation benefits for those clients who choose OMAL products. The attention for product design processes based on sustainable principles is also proved by a Solidworks design software called "Sustainability", that allows evaluations and analysis on the resources used to manufacture a certain article. The use of this instrument is in line with our company mission, that aims not only at designing efficient and reliable products at a compatible market price, but also at guaranteeing efficient and reliable products with energy saving, as a result of consuming less energy and therefore having less environmental impacts.

RESEARCH AND DEVELOPMENT

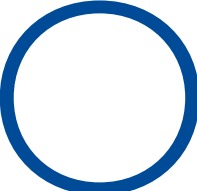
 OMAL is active in research and development thanks to several collaboration with universities, including the University of Brescia, as a part of a technical project that will lead to a collaboration aimed at a common planning and student internships in the company.

SOLIDWORKS FLOW SIMULATION

 In 2018 OMAL bought and used the Solidworks Flow Simulation software. Flow Simulation is a powerful tool for computational fluid dynamics that enables designers to quickly and easily simulate liquid or gas flows, heat transfer and fluid forces, all fundamental elements to create successful design projects. The software enables to simulate liquid and gas flows in real conditions, run hypothetical scenarios and efficiently analyze the effects of fluid flows, heat transfer and their relative forces on submerged or surrounding components.



PRODUCT CERTIFICATIONS

In OMAL, obtaining product certifications must be jointly carried out by the Integrated Management System Manager, Sales Manager, Chief Designer and the General Management in order to ensure the best promotion of OMAL brand and the values it intends to sponsor, in line with the company Mission *“We guarantee a better world for our children. Thanks to our products, we safeguard the environment around us and we tangibly improve the quality of life, making our plants safer and more reliable”*.

OMAL is proud to have a broad range of certifications for the main four families of products:

I) BALL VALVES

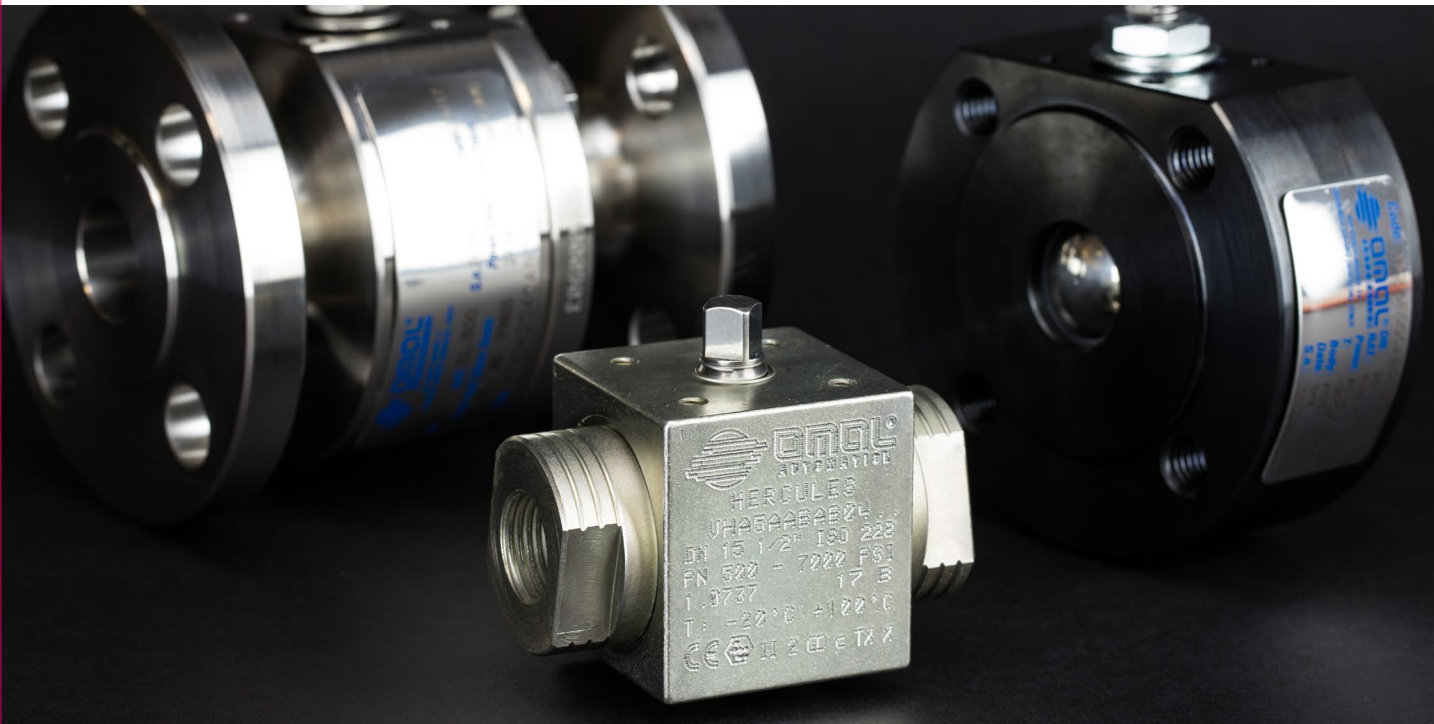

Certificate of conformity in accordance with 2014/68/EU PED Directive

Certification for the Quality Management System applied to the design, manufacturing, final inspection and testing of industrial valves in accordance with the requirements of 2014/68/EU Directive - MODULE H Full Quality Assurance.

Conformity in accordance with 2014/34/EU ATEX Directive

Declaration indicating that the Quality System implemented for the design, manufacturing, final inspection and testing of industrial valves complies with the provisions of 2014/34/EU ATEX Directive, for equipment intended to be used in potentially explosive atmospheres.

API6D Certificate

Certification for the Quality System implemented to the design, manufacturing, final inspection and testing of ball valves for oil and natural gas industry, in compliance with the API6D standard and authorization to apply the API monogram by the American Petroleum Institute.

[EAC TR CU 010/2011 Certificate and EAC Ex TR CU 012/2011 Certificate and EAC TR CU 032/2013 Certificate](#)
 Certificates of product compliance with the technical regulations of the EuroAsec customs union (Russia, Kazakhstan, Byelorussia, Armenia).

UKR Certificate

Certification of compliance of the product with the technical regulations applicable in Ukraine.

FIRE SAFE API607/ISO10497 Certificate

Certification of the pressure-containing capability of a valve under pressure, during and after the fire test according to API607/ISO 10497 standards.

FUGITIVE EMISSION EN ISO 15848 Certificate

Certificate of compliance with the requirements of non-emission of hazardous substances, according to UNI EN ISO 15848-1 standard.

TA-LUFT Certificate

Certificate of compliance with the requirements of non-emission of hazardous substances, according to TA LUFT VDI 2440 standard, for application in volatile air pollutants and hazardous fluids.

SIL3 IEC 61508 Certificate

Certificate of compliance with the IEC 61508 standard, of the level of functional safety of a product to be integrated in a system with a level of functional integrity up to SIL3.

ADR - EN14432 Certification

Certification in compliance with UNI EN 14432 standard for valves as service equipment to be used on tanks for the road transport of liquid chemicals according to the ADR Agreement.

IGR Certification

Certification in compliance with the IGR n. 12-0042-1 guidelines and data sheets n. 19021, 19022, 19023, 19043 for chemical industry.

PROCHEMIE BALL VALVE

The high performances of PROCHEMIE 60 valves allow to obtain remarkable environmental advantages:

- Long operative life (TA LUFT Certificate for 60,000 cycles);
- High maintainability (e.g. easy change of components);
- High recyclability of materials (e.g. 100% recovery of metal components);
- Prevention of environmental pollution thanks to the external sealing system.

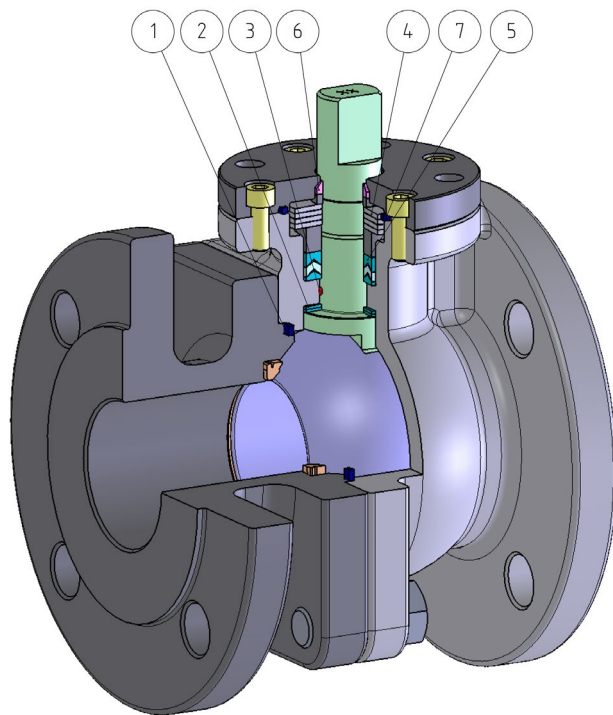

Some features are provided below:

- 1.** Stretch graphite seal: tightness towards outside is granted, independently by the thermal excursions to which the valve is subjected.
- 2.** Double antifriction washer: less break away torque is granted and less wear comparing with the execution with the single washer.
- 3.** Anti-static device (electrical continuity between ball, stem and body): static electricity which can cause sparks and fire is prevented. contact safety is ensured throughout the entire life of the valve.
- 4.** Spring washers with shaft rotation independent preload: In this way the wear of “V” seals is avoided and the high cyclicity of the valve is ensured. The spring preload allows to keep the “V” seals energized, preventing external leaks, even against high temperature variations.
- 5.** “V” seals pack with 3 seals: it ensures a perfect tightness even after a high number of cycles.
- 6.** Stem bushing: operates as stem guide and secondary sealing.
- 7.** Cover Sealing + Stem bushing: the valve is equipped with a secondary sealing chamber independent from the “V” seals pack.

II) BUTTERFLY VALVES



DIN DVGW Certificate for GAS EN 13774

Certificate for materials, design, production and test of butterfly valves for gas distribution systems according to UNI EN 13774 standard.

Certificate of Compliance with 2014/68/EU PED Directive

Certification for the Quality System implemented for the design, manufacturing, final inspection and testing of industrial valves according to the provisions of the Directive 2014/68/EU - MODULE H Full Quality Assurance.

Compliance with 2014-34-EU ATEX Directive

Declaration that the Quality System implemented for the design, manufacturing, final inspection and testing of industrial valves complies with the provisions of 2014/34/EU ATEX Directive, for equipment intended to be used in potentially explosive atmospheres.

RINA MAC242716CS Certificate

Certificate of product compliance with the Regulation of RINA, Italian Naval Register, for the installation of butterfly valves on ships listed with RINA.

EAC Ex TR CU 012/2011 Certificate

Certificato EAC TR CU 032/2013

Certificate of product conformity with the technical regulations of the EuroAsec customs union (Russia, Kazakhstan, Belarus, Armenia...).

2. THE COMPANY

UKR SEPRO Certificate

Certificate of product conformity with the technical regulations in Ukraine.

ADR - EN 14432 Certificate

Certification in compliance with UNI EN 14432 standard for valves as service equipment to be used on tanks for the road transport of liquid chemicals according to the ADR Agreement.

III) PNEUMATIC VALVES



Certificate of Compliance with 2014/68/EU PED Directive

Certification for the Quality System implemented for the design, manufacturing, final inspection and testing of industrial valves according to the provisions of the Directive 2014/68/EU - MODULE H Full Quality Assurance.

Compliance with 2014/34/EU ATEX Directive

Declaration indicating that the Quality System implemented for the design, manufacturing, final inspection and testing of industrial valves complies with the provisions of 2014/34/EU ATEX Directive, for equipment intended to be used in potentially explosive atmospheres.

EAC TR CU 010/2011 Certificate

EAC Ex TR CU 012/2011 Certificate

EAC TR CU 032/2013 Certificate

Certificate of product conformity with the technical regulations of the EuroAsec customs union (Russia, Kazakhstan, Belarus, Armenia...).

UKR Certificate

Certificate of product conformity with the technical regulations in Ukraine.

IV) ACTUATORS



Compliance with 2014/34/EU ATEX Directive

Declaration indicating that the Quality System implemented for the design, manufacturing, final inspection and testing of industrial valves complies with the provisions of 2014/34/EU ATEX Directive, for equipment intended to be used in potentially explosive atmospheres.

SIL3 IEC 61508 Certificate

Certificate of compliance with the IEC 61508 standard, of the level of functional safety of a product to be integrated in a system with a level of functional integrity up to SIL3.

EAC TR CU 010/2011 Certificate

EAC Ex TR CU 012/2011 Certificate

Certificate of product conformity with the technical regulations of the EuroAsec customs union (Russia, Kazakhstan, Belarus, Armenia...).

2. THE COMPANY

UKR Certificate

Certificate of product conformity with the technical regulations in Ukraine.

TAP00001G5 Certificate

Certificate of conformity for DAN-SRN pneumatic actuators with DNV-GL Technical Regulations for ships classification, Pt.4 Ch.6 Piping systems. DNVGL- OS-D101 Technical Regulations – Marine and machinery systems and equipment, Edition January 2018, for shipboard installations.



PRODUCTS AND APPLICATIONS

The main applications of OMAL products are:



2.3 PRODUCTION

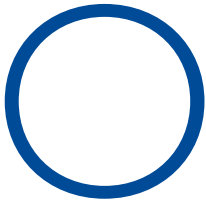

MAL production unit is located in the Passirano plant. Built in compliance with the best environmental and architectural standards, since 2016 the plant is the hub where OMAL valves and actuators are born, from the technical project to the ready-to-use final product.

During 2018, the company commitment corresponded to the development of advanced processes of Industry 4.0, as a result of the high level of automation reached. In this framework, the main working areas have been:

PROCESS AUTOMATION

The machines and equipment used in the production units (mechanical manufacturing and plastic molding) of the Passirano plant are about 60, divided in 25 automated work-stations, including 16 robotized: an important level of automation that allowed management, control and efficiency improvements (with savings in energy consumption up to 30%) and significant benefits on the final quality of the product.

PASSIRANO PRODUCTION PLANTS

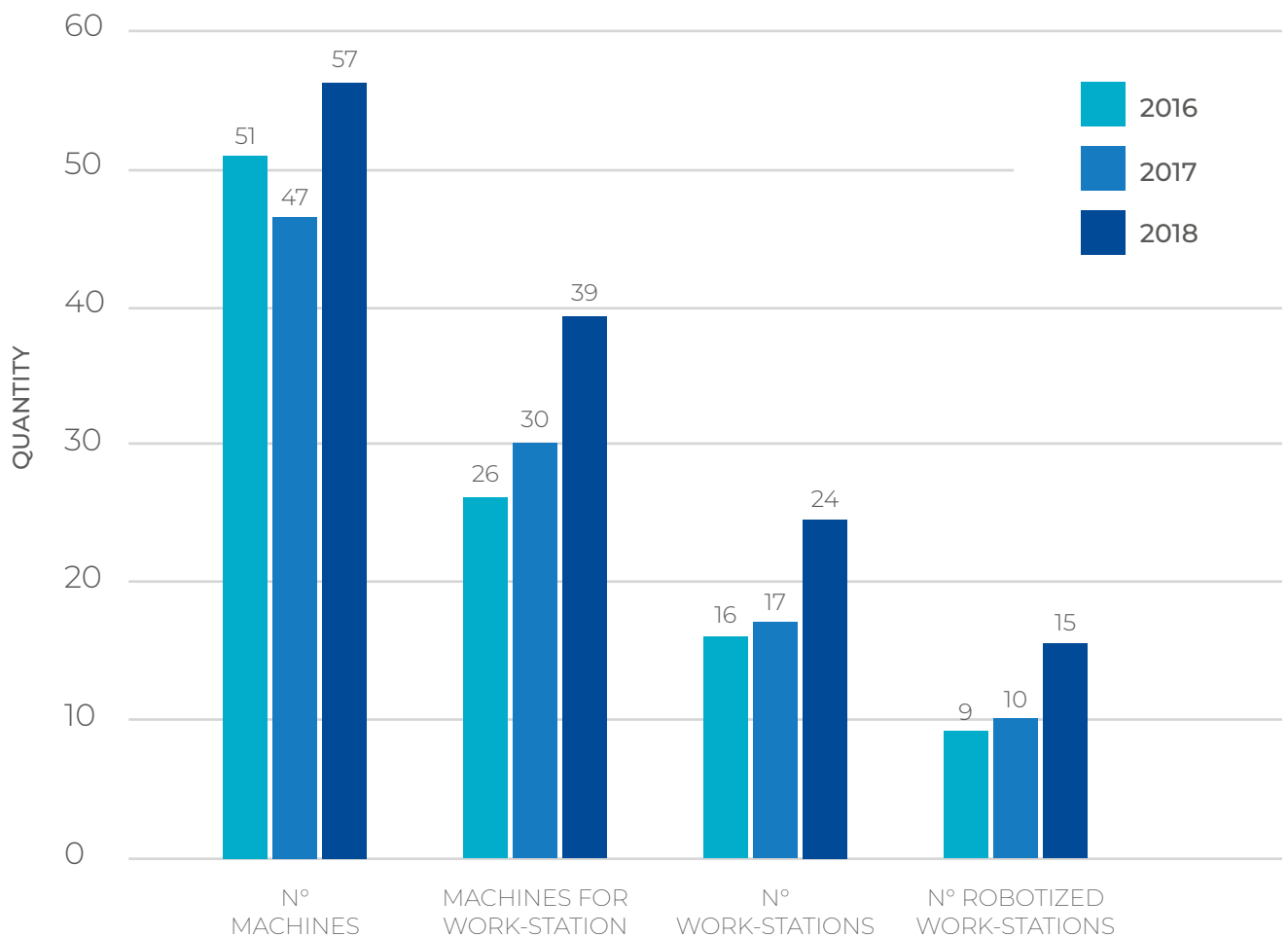

Automation is applied everywhere is possible, in order to enhance management and control improvements, as well as process efficiency. There are therefore automated processes for marking and palletizing finished products (e.g. pneumatic actuators).



In the Rodengo Saiano plant, the logistic department has as well undergone a program of automatic handling of materials, following IoT principles, with vehicles equipped for a combined driving system “on track” or “free”: thanks to navigation inductive technologies and lasers, it’s possible to easily move around the warehouse passages and shelving systems without the guidance or intervention of an operator.

Today only one vehicle of this kind is working, but by next spring two new vehicles will operate according to the following procedures:

- the vehicles wait for the communication of the mission, sending, via WIFI areas, their position and status to the central control station (FST).
- ERP, managing the production, creates missions directly on the central control station (FST) and then the missions, ranked according FIFO criteria, are elaborated and assigned to the vehicle.



INDUSTRY 4.0

The net connection represents the switch to IoT (Internet of Things), where “intelligent” objects are required to communicate in an increasingly interconnected way.

The new structure of the company IoT is the essential support to increase efficiency in production processes, sustaining plant and manufacturing automation with communications between “intelligent” objects, and to enable the development and maintenance of software applications for supervision, operator interface, data acquisition and control, remote or “mobile” systems data access.

To this end, OMAL has activated the applications MOVICON 11 (monitoring vision and control) – today used both in Passirano and Rodengo Saiano – and Movicon Pro-Energy, a new product that we are going to integrate into Movicon 11 during 2019, to measure and manage energy consumption of each production plant. The data analysis allows to quickly identify the critical points of the production process and improve them to reach the maximum efficiency and productivity of the system. All plants were connected to acquire and receive data remotely. The new production plants, equipped with a net connection to benefit of remote assistance services, meet all Industry 4.0 requirements.

IoT NEW STRUCTURE

The realization of the new plant in Passirano represented an opportunity for a project that involved also the Rodengo Saiano headquarters and ensured high reliability and protection of company data to all corporate structures. An active and passive data infrastructure was created for the new production hub of Passirano, connected online to the Rodengo Saiano headquarters.

The areas involved in the project were passive Infrastructure, voice communication, networking, wireless and perimeter security.

More specifically:

- *Networking infrastructure*

Adding a new location to be linked to the star center of Rodengo required an expansion of the Core active apparatus. This has represented an opportunity to submit a renovation project for the active apparatus of the two main racks of the Rodengo headquarters: Server Room and Offices. Compared to the previous configuration, this new connection has resulted in a band expansion and a redundancy, so that, in the event of falling of one of the two links, the remaining would ensure a continuous communication. To complete this infrastructure, a backup radio connection between the two locations of Rodengo e Passirano was planned, in order to keep data communication also in case of interruption of the main optical fiber connection.

- *Perimeter security*

Security has become a necessary key element in planning a new network. That's why, also for OMAL new site, we have expanded our perimeter protection system. In the final version, the previous firewall has been replaced by a new couple of devices with high reliability configuration, able to manage the internet connection of all our locations. The security measures have been completed with anti-spam and anti-virus filters and customized internet policies.

EPDM DEVELOPMENT

Next step in EPDM development includes the traceability and storing of shared documents and the handle of notifications, making easier to independently access and use the system for authorized users. To this end, we have planned for the current year a set of customizations of the Application for drawings and specs traceability, and the “link” to the management system, only then we will determinate and formalize the operability.

SCHEDULER

While the production scheduler has been working for over a year, the scheduler for the assembly of finished products is currently under development. In this process, we have limited the use of this tool to the production of VIP Valves and Inclined Valves, the only products for which a real scheduling was possible, thanks to substantial quantities, inventory stocks and reorganization policies. However, the implementation will start when the new assembly and testing plant of VIP Valves, that has recently started to operate, reaches its full capacity.

JPA - PROJECT MANAGEMENT

For a better management of activities and projects related to each process, the Management has introduced a Project Management System, through the JPA software, which enables a joint management of activities, from their planning and progress to their completion. JPA also manages some critical or strategic “internal processes”, attributing responsibilities and tasks (through a specific work-flow) within procedures that are necessary to speed up relations between internal processes in a more controlled way. Some of these processes have ad hoc regulations and certifications, for instance the management of orders from those countries subject to trading restrictions or where there are in place specific regulations on movement of goods (e.g. DUAL USE Regulation), other processes are internal initiatives that prove the company's interest in making daily work operations smoother and more efficient.

The first activities managed by JPA have been:

- 1) Offers Management/Sales inquiries/Technical department
- 2) Expense reports
- 3) Time changes tool setup – production

Beside the PM system, an activity declaration procedure has been introduced, for the indirect ones, in order to monitor the work load and the related criticalities and improve the efficiency of all departments.



2.4 STAFF

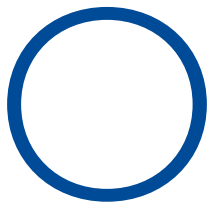

MAL internal organization is divided between management and production units, according to the chart below. The centralization of all offices in the Rodengo Saiano plant, where also the general management is based, allows to manage every internal process in a more strategic and structured way.

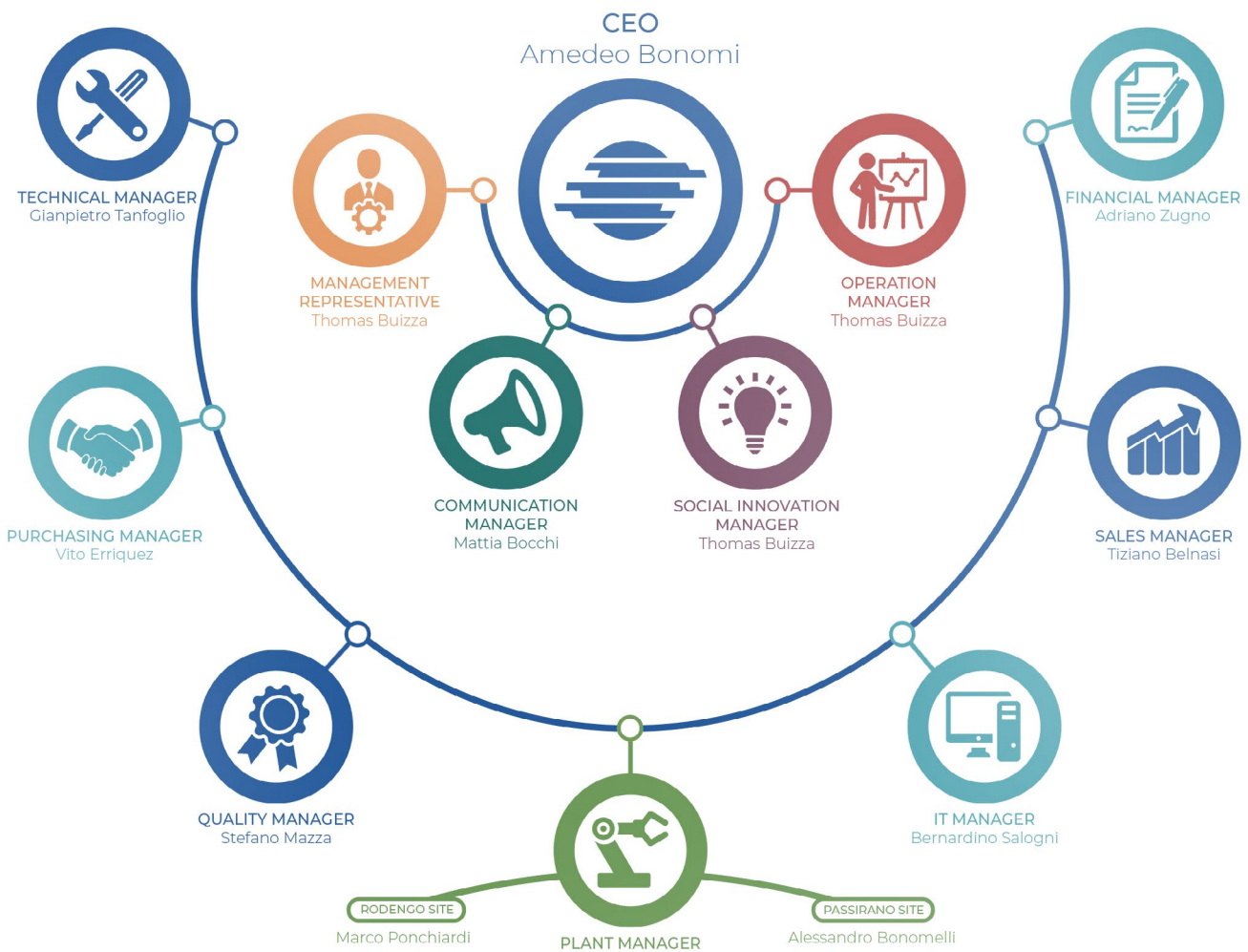

In 2018, OMAL had a staff of 91 people, divided between the two plants of Rodengo Saiano (51) and Passirano (49). As illustrated below, gender distribution indicates a predominance of male staff (83,5% of personnel), typical of OMAL industrial sector. As far as concerns the type of contract, the main type is open-ended contracts: only 2% of contracts are fixed-term and they are all aimed at a later permanent recruitment. With regard to staff category, 53% of the workforce are technicians and employees, while 47% are factory workers. By the end of 2018, the company employed also temporary agency workers, 1 employee and 4 factory workers.

2018 STAFF

Observing OMAL staff composition, 47,3% is under 35 years old, 9,9% is over 50 and 42,9% is between 36 and 50, as the diagram on the right shows. The average age of managers is 48.

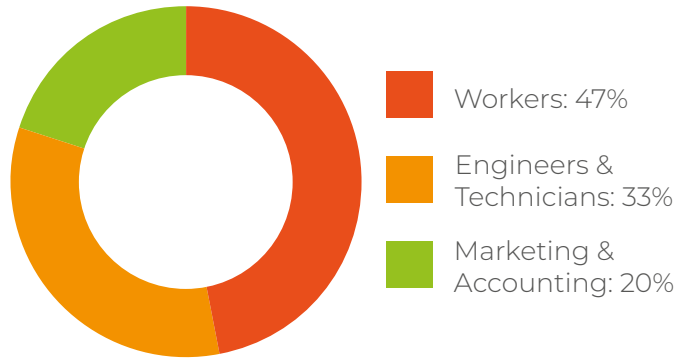

According to their length of service, 62% of staff have worked for the company for less than 10 years, as shown below, with a new generation of employees to whom the Ownership has given trust and responsibility to carry on the growth and innovation process. 18,0% of staff have been working for OMAL for over 20 years.

OMAL STAFF BY GENDER

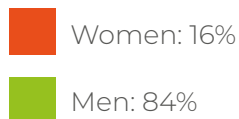

OMAL STAFF BY AGE

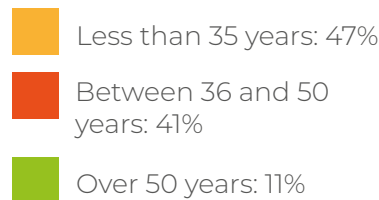
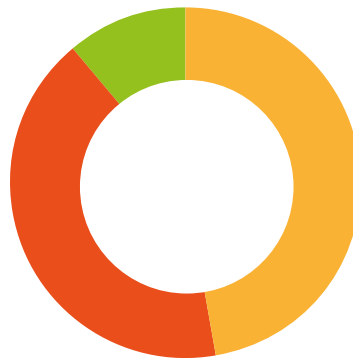

OMAL STAFF BY LENGTH OF SERVICE

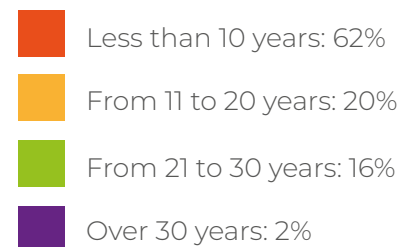
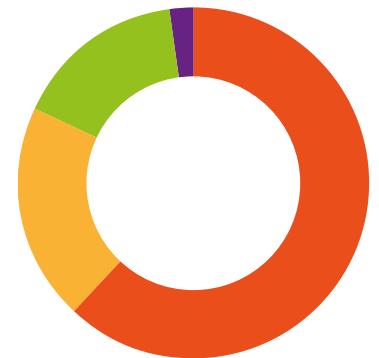

In 2018, n.9 people were hired, 3 factory workers and 6 office employees. Among these new recruitments, there were 3 open-ended and 6 fixed-term contracts. The people who left the organization in 2018 were 11, 3 workers and 8 employees.

About staff composition, it is worth mentioning that OMAL is contributing to the social inclusion of disadvantaged people, in compliance with Law n. 68/1999.

FOCUS: STAFF TRAINING AND SERVICES

In 2018, we activated many updating courses on health and safety in the workplace and environmental issues, as well as internal training programs (corporate self-training, in particular under the program “In FormAzione”) – aimed at increasing our staff skills – and specific training programs to support the use of new software and applications, introduced to simplify or improve internal management. The table and charts below show specific data on these activities.

| OMAL 2018 | TRAINING PROVIDED | | AVERAGE |
|-----------------------------|-------------------|-------------|-------------|
| Health-Safety & Environment | 362 | 51% | 3,98 |
| Quality | 351 | 49% | 3,86 |
| Total | 713 | 100% | 7,84 |

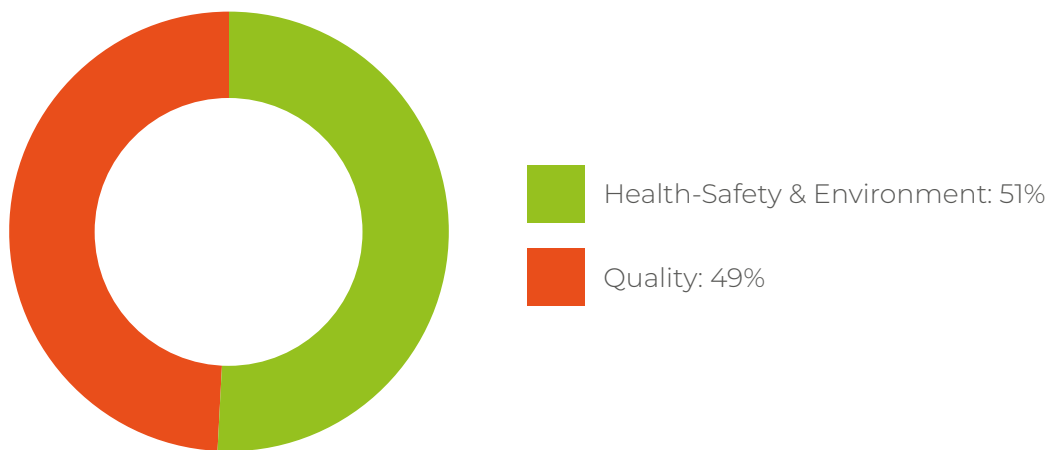

Throughout the year, we also organized other activities for our staff: according to tradition, the two main events where the company meets the staff of the two brands OMAL and Actuatech took place in charming locations, to discuss future projects and spend some recreational time together.

2. THE COMPANY

The first of these event was the Empowered Day, that took place in June 2018 and was developed around 2 main themes: enhancing business and Brand importance. Speakers of this event were OMAL and Actuatech Sales General Managers. The first speaker insisted on the central role of team work, that, with its motivating value, participates in the company's success especially for two reasons: our brand and people. The second speaker illustrated the important commercial steps that were taken in marketing and selling pneumatic actuators. Then, the main steps that have allowed the company to succeed in the market since 2001 were remembered. The Owner, as customary, closed the conference reminding the centrality of empowered performance and the need for a strong engagement of all collaborators to reach a company's vision that really can make a difference.



The second event was the Christmas dinner, a tradition that closes the work year and it is celebrated with all present and past employees, namely the company's retired employees. As tradition dictates, during the Christmas dinner a lottery took place, with the gifts received by the company throughout the year as prizes.



Again, during 2018 the ND24 Application Technology was fully implemented, also through the App. "Info-day pocket" (integrated with the ND24 software used for staff management), that enables to manage holiday requests, permits, working hours and clocking in/out data validation, pay slips consultation and acquirement of fiscal documents (e.g. single certification) that the employees can directly submit via their smart phones. This tool was positively received and all employees regularly use it.

In 2019, we are going to activate a module to manage staff training and health protection, in support to the current activities for implementing the ISO 45001:2018 standard.

2.5 SUPPLIERS

The choice to keep our production in Italy is also reflected in the supply chain, that for its 90% is located in Italy, less than 200 Km from OMAL. It is also noted an increase of purchases from Italy and a correspondent decrease of purchases from extra EU countries.

In 2018, products of EU origin reached the percentage of 85%, with an increase of 4 percentage points compared to the 2017 figure (81%).

| WORLD PARTITION | INCIDENZE |
|--------------------|-------------|
| EU Total | 84,92% |
| Extra EU Total | 15,08% |
| World Total | 100% |

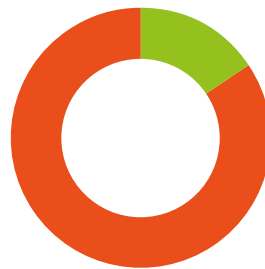

PARTITION BY ORIGIN
UPDATES BY VALUE

- Extra EU Total: 15,08%
- EU Total: 84,92%

OMAL believes that, by respecting ethical principles and environmental sustainability, it is possible to obtain a responsible and efficient supply chain, where each exchange happens with mutual respect and trust. The principles shared by OMAL with its suppliers can be summarized as follows:

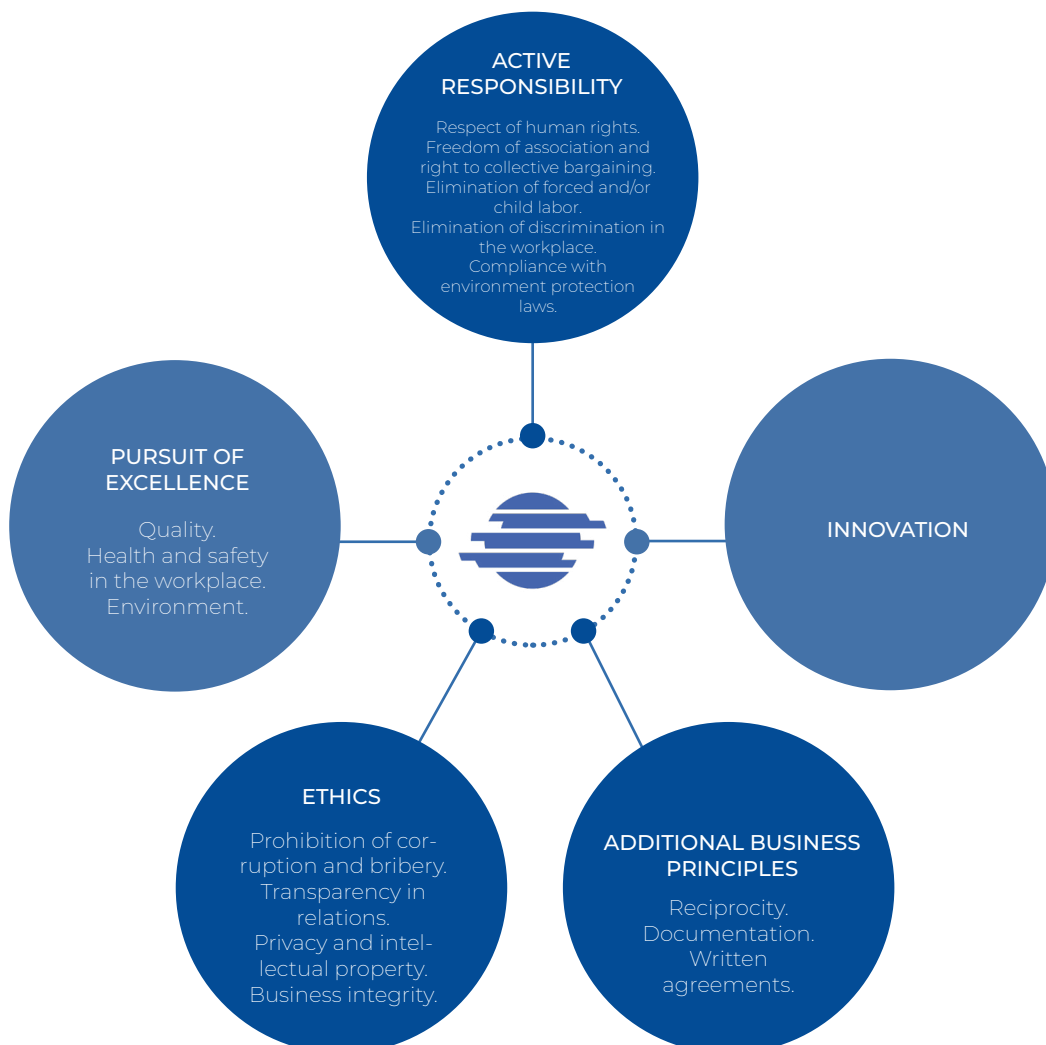

2. THE COMPANY

As illustrated, OMAL “Supplier Code of Conduct” is structured in 5 pivot areas based on the principles of active responsibility, excellence, innovation, ethics and business principles. OMAL requires its suppliers to fully implement these principles. The relations with suppliers, however, are not merely passive, and we imagine that this Code may represent a starting point for a continuous exchange, forcing also OMAL to always refer to it when deciding its business initiatives.

About its rafting method, the Code refers to the following initiatives, standards and documents:

- United Nations Global Compact: www.unglobalcompact.org
- Universal Declaration of Human Rights: www.ohchr.org/EN/UDHR/Pages/Language.aspx?LangID=itn
- International Labour Standards (ILO): www.ilo.org/rome/risorse-informative/_servizio-informazione/pubblicazioni/WCMS_151918/lang--it/index.htm
- OMAL Code of Ethics “Ethics in OMAL”: www.omal.it/Qualita-e-responsabilita/AZIENDA/Politica-sociale



OMAL Supplier Code of Conduct 2018

Continuing OMAL path towards the respect of Sustainability within the company, we have defined a Green Procurement Policy, under which the company is committed to identify and manage all social and environmental impacts related to the production and sale of industrial valves and actuators, including those deriving from the supply of products and services, by directly involving its supply chain. It's a long-term process, because we consider our suppliers as important partners to build responsible, and therefore sustainable, practices.

To this end, we intend to:

- I Implement our policies and practices according to our values, the principles of our Code of Ethics and in particular of the Supplier Code of Conduct, respecting the 10 principles of the United Nations Global Compact, as listed below.

I: to Support and respect the protection of internationally proclaimed human rights within the respective spheres of influence.

II: to Make sure that one is not complicit, even indirectly, in human rights abuses.

III: to Uphold the freedom of association of workers and the effective recognition of the right to collective bargaining.

IV: to Uphold the elimination of all forms of forced and compulsory labor.

V: to Uphold the effective abolition of child labor.

VI: to Uphold the elimination of any forms of discrimination in respect of employment and occupation.

VII: to Support a precautionary approach to environmental challenges.

VIII: to Undertake initiatives to promote greater environmental responsibility.

IX: to Encourage the development and diffusion of environmentally-friendly technologies.

X: to Work against corruption in all its forms, including extortion and bribery.

- 2 Select business partners and organizations that:
 - share our values and awareness on social and environmental sustainability, signing the Supply Code of Conduct;
 - comply with CSR and environmental regulations, signing the legal requirements of the supply agreement;
 - adopt initiatives for pollution prevention and/or environment safeguard;
 - have already implemented, or intend to, an environmental management system.

- 3 Support our suppliers in implementing more virtuous practices, in order to minimize environmental and social impacts along the supply chain.

- 4 Monitor the sustainability of the supply chain, especially the most critical processes.

- 5 Integrate in our contractual documents bonding requirements on sustainability principles and share them with our supply chain.

2.6 CLIENTS

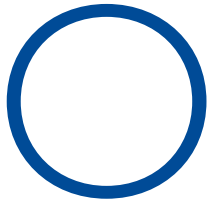

MAL differentiates its clients by their kind (e.g. distributor, machine manufacturer or engineering company, final client etc.), and then subdivides them according to their industrial sector and the lines of products provided.

At operational level, the Sales Department divides clients by their geographical area, each managed by an Area Manager and a specific back-office resource, or by relevance of their purchases, where the so-called “managerial” client are directly followed by the Sales General Management.

Today OMAL is proud to sell in 94 countries, where it has exclusive and non-exclusive distributors, or agents who can follow different industrial sectors. What OMAL can offer to its clients, in addition to products with high technical quality, is a service of constant technical assistance and customization of answers, in order to provide a 360° service, integrating the supply with a technical knowledge that is the result of over 37 years of experience.

OMAL GLOBAL MARKET

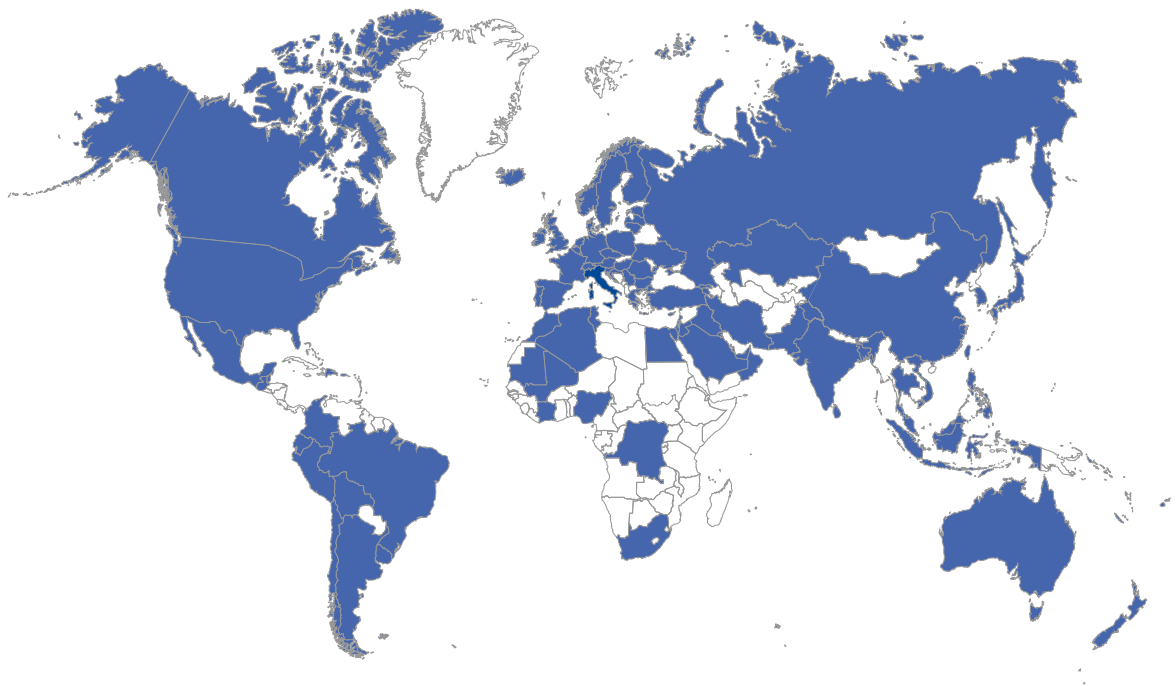
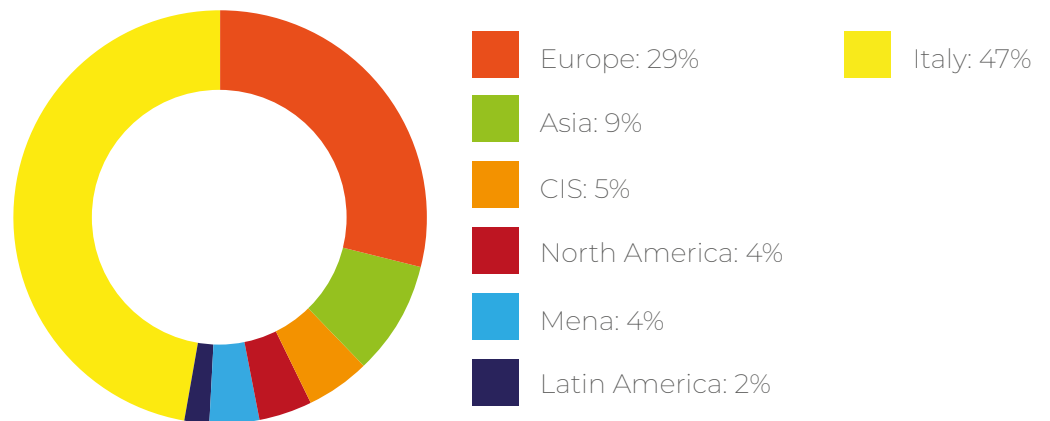

The profile of a client is an user able to understand technical advantages and pretend high performance. The client is one of the most important stakeholder to measure the effectiveness of our choices and resources, so he is at the core of the company's efforts to keep improving and he is the recipient of the motto "EMPOWERED PERFORMANCE", that summarizes the company's commitment to present products and services above the technical and qualitative standards of the market.

That's why OMAL has opened several communication and business update channels, among which we recall the most important ones: sector trade fairs (i) and sales conferences (ii).



FOCUS: 2018 TRADE FAIRS

In 2018, following our strategic plan and operational program, OMAL directly participated to several trade fairs in different sectors and countries. In each fair, OMAL was able to distinguish itself, showing to its hosts the state of the art of technical design and production of valves and actuators, also using advanced audio-visual supports (e.g. 3D videos and tutorials on product maintenance), and underlying OMAL Social Innovation approach.

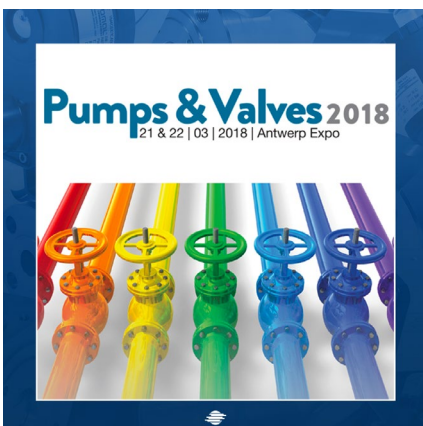

PUMP & VALVES 2018 Expo

(with our local partner PRODIM)
21 - 22 March 2018 - Antwerp, Belgium

PUMP&VALVES is a sector-specific exhibition, where OMAL co-participated with its local distributor PRODIM, to present products to final clients and professionals of plant maintenance in BENELUX. This is the most important trade fair in the region for the processing of liquids and gases sector and welcomes over 5.000 visitors in 2 days.



ACHEMA 2018

11 - 15 June 2018 - Frankfurt am Main, Germany

ACHEMA is a world exhibition with leading companies in the chemistry and bio-technology industry. It takes place every 3 years in Frankfurt and involves about 160.000 experts in the field. Achema is considered the best platform to present new technical solutions and enhance the dialogue between manufacturers and users, in order to create new collaborations. OMAL has always supported chemical industry, because it is a field that requires top performances and high safety standards and where the trends towards more automated and intelligent processes find in OMAL an ideal partner. OMAL starring product for this exhibition was the PROCHEMIE-60 valve, that counts many certifications and qualifies to be used also in the German chemical plants, among the most demanding in the world.

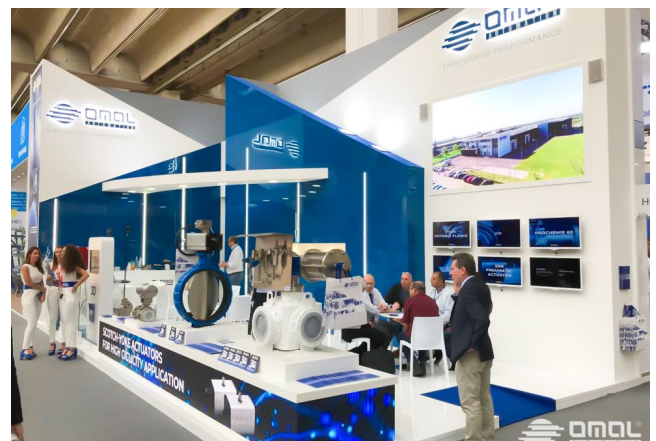

OMAL Stand in Achema 2018



The 31st WORLD LPG FORUM 2018

2 - 4 October 2018 - Houston, USA

The World LPG Forum is the global event for the GPL sector. It is organized by the WLPA, the world organization that reunites leading companies, decision and policy makers and users of this world-spread technology. The world edition has 400 exhibitors from 76 countries: OMAL was also here able to reaffirm its leadership in manufacturing valves and actuators for this sector.



OMAL[®]

AUTOMATION

EMPOWERED PERFORMANCE

**HOUSTON,
DO WE HAVE A PROBLEM?**

THANKS TO THE **EMPOWERED PERFORMANCE**
OF OMAL PRODUCTS, YOU WON'T NEED TO WORRY
EVEN IN THE MOST **ADVERSE CONDITIONS**

OMAL S.p.A.
HEADQUARTERS: Via Ponte Nuovo, 11 - Rodengo Saiano (BS) Italy
PRODUCTION SITE: Via Brognolo, 12 - Passirano (BS) Italy



OMAL
APP

www.omal.it   



ADIPEC 2018

12 - 15 November 2018 - Abu Dhabi, UAE

ADIPEC (Abu Dhabi International Petroleum Exhibition & Conference) is an yearly fair for gas and oil, one of the most relevant world event in this sector, with more than 145.000 visitors and 2.200 exhibitors. Since 2013, OMAL has participated in the Italian Pavilion, proud to represent the Italian excellence in this field. The event, as every year, takes place in the ADNEC exhibition center in Abu Dhabi from 12 to 15 November and reunites all the main actors in the gas and oil field. During the event, the latest technologies and equipment for gas and oil exploration, production, refining and transport are introduced.

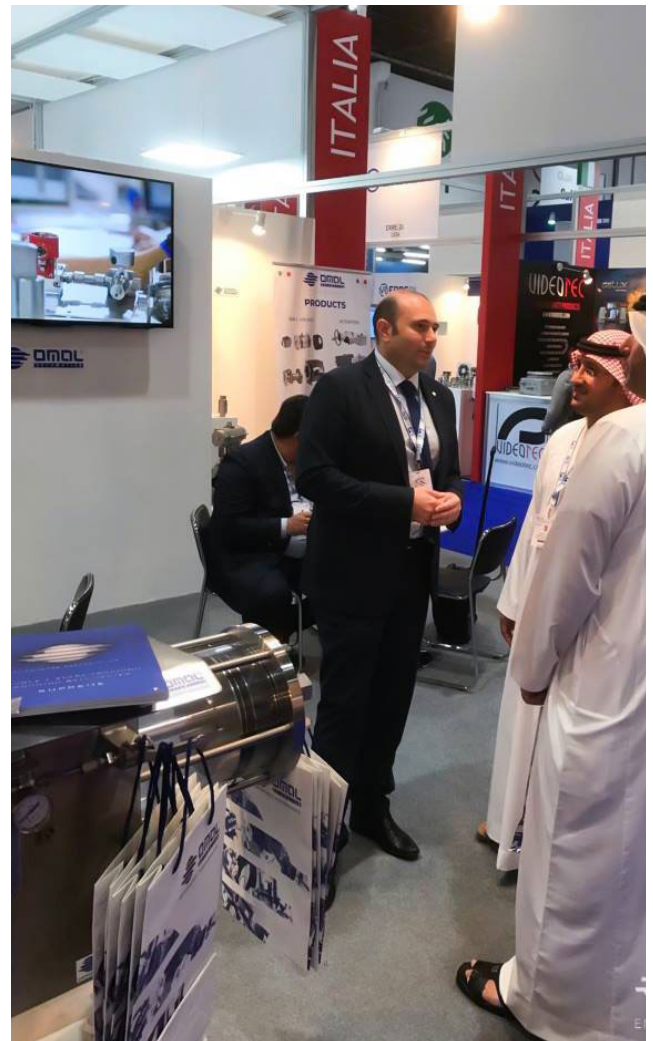



VALVE WORLD EXPO

27 - 29 November 2018 - Düsseldorf, Germany

VALVE WORLD EXPO is the biennial trade fair that better represent the state of the art in the valve and actuator industry, a benchmark in this field. The 2018 edition reunited 12.000 field professionals from 86 countries. A unique opportunity for visitors who can, for three days, find all specific information on innovations, new processes and products in one place. In this fair OMAL participated with its partner company ACTUATECH and showed the latest developments of its range of valves and actuators both to loyal clients and new potential ones, who are looking for a reliable partner to escape a market characterized by low-price products with consequent doubts on reliability.

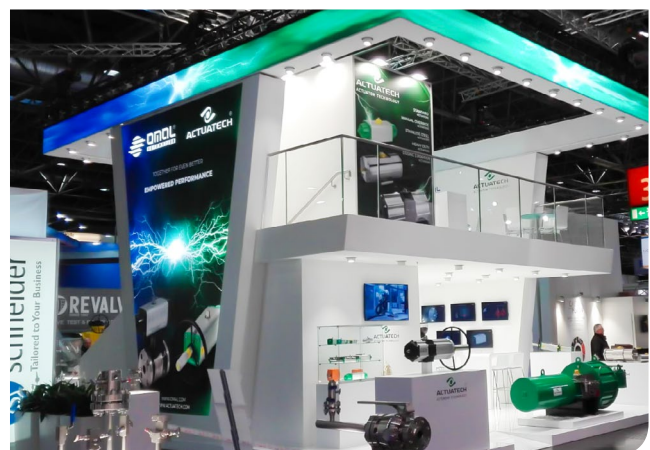
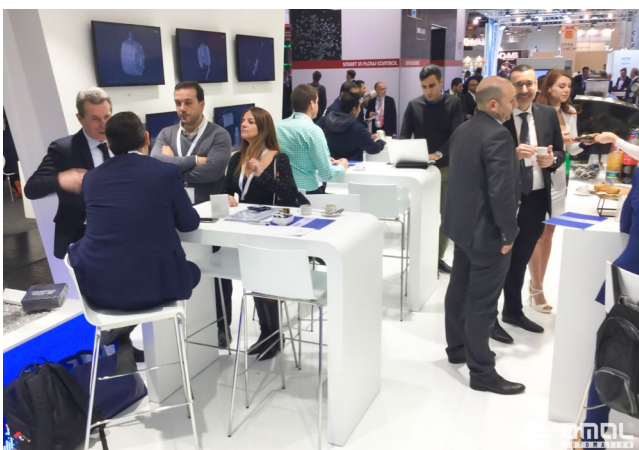



ACTUATECH
OMAL
AUTOMATION

TOGETHER WE ARE
ELECTRIFYING



WWW.OMAL.COM
WWW.ACTUATECH.COM

3
B
64

**SCOTCH-YOKE ACTUATORS FOR
HIGH CICLICITY APPLICATION**



FOCUS: SALES CONFERENCE

Since 2010, OMAL has introduced a regular appointment with its network of Italian agents and foreign distributors, as a tool to keep them constantly updated on the latest production news and to share business strategies, as well as facilitate networking between its partners and keep them informed.

The chosen format is a collective two-day event, organized by different business areas. In 2018 there were 3 Sales Conferences, for the first time all of them took place in our Italian division, in order to allow everybody to see the great efforts in terms of investments and re-organization implemented in the past 2 years in the group production plants.

In 2018, 65 partners have participated, divided as follows:

ITALY: 12

EUROPE AREA: 35

MENA & ASIA-PACIFIC AREA: 18

The topics covered in the 2 days were:

- Analysis of sales performance for 2017
- Introduction of the new range of DAN/SRN actuators, launched in 2018
- Updates: new catalogue, new actuators, new operational tools
- 2018-2019 Development strategy
- Sharing of case-history e networking

“

“We closed the year 2018 with a positive result in sales, that allows a consolidated growth of the company, although not in line with the expected targets. The growth and optimism of 2018 first semester moved sharply downwards during the last 4 months of the year, following a general economic slowdown at Italian and international level.

We believe this instability will also characterize the market in 2019.

Nonetheless, we remain optimistic that some of the changes implemented in 2018 (new price lists, launch of the new series of actuators that has impacted all OMAL production range, new digital business tools, revision of some sale and agency agreements) will have positive effects on 2019 sales; it is however essential to keep our market presence and the high – already excellent - level of quality of our products and customer service, to pursue the goal of distinguishing ourselves from our many competitors”.

”

Tiziano Belnasi – OMAL Sales Manager



2.7 COMMUNICATION

About sense of identity, nothing can better translate the values of a company than its communication, to the point of becoming a true strategic asset to consolidate relations with direct and indirect stakeholders, internal or external. The relevance of communication is not to be only considered for the power of its message, but for the ways and channels that are chosen or imagined to spread it. As far as concerns communication, in 2018 OMAL focused on:

WEBSITE > OMAL new website represented a big and complex project, considering the huge number of products and codes to be inserted. The main novelties compared to the previous version are:

- Responsive Graphics (compatible with smart-phones, tablets etc, designed to 100% suit any kind of screen, regardless of its size);
- Possibility of directly setting an article up on the website, configuration valve + actuator;
- Possibility of watching and downloading 3D videos of the selected product;
- Possibility of searching any article with a free search of key words, article name, product code or part of code;
- For advanced authorized users: possibility to see the price of an article directly on the website.

From a graphic perspective the website is modern, clean, minimal, with very big pictures and 9 languages available (ita, eng, de, spa, fr, por, tk, ch, ru).



Omalfre una gamma completa di valvole, disponibili in asse libero, con leva o azionate dai nostri attuatori. Le valvole OMAL sono studiate e realizzate per far fronte alla maggioranza delle applicazioni, in tutti i settori dell'industria.

VALVOLE A SFERA
In acciaio al carbonio, acciaio inox e altri materiali.
Valvole a sfera con pressioni nominali fino a PN 500 e ANSI 2500 e misure

VALVOLE A FARFALLA
In ghisa, acciaio inox, PVC
Valvole a farfalla, disponibili nelle versioni wafer e lug, nelle misu

X CHIUDI
NEXT EVENT
OMC 2019
27-29 MARZO
RAVENNA
OMC 2019
Ravenna, 27-29 marzo 2019

SOCIAL MEDIA > In 2018 the use of Social Media as a tool to share corporate activities continued, with particular reference to new projects, ADV, business travel reports, trade fairs and company events. Throughout 2018 we recall, among many, three trend posts: **“OMAL Features & Benefits”**: a series of charts that show plus, features and benefits of OMAL products by drawing parallels with the natural world, especially animals. E.g. “Hercules cockroach”, “Koi carp” etc. **“Actuality and Recurrence”**: posts dedicated to events apparently far from the valves & actuators world but connected to OMAL products. Video **“What’s on OMAL”**: taking advantage of the growing tendency of using videos (instead of pictures) on social media, we realized some short videos to tell the plus of each OMAL division (assembly, production, technical department, quality and purchasing departments etc.).

so small
so strong



Hercules Beetle is able to carry up to 100 times its body mass!
Hercules Valve is able to intercept pressures up to 500 bar!



so many cycles
and still going



Koi Carp has been reported to achieve ages of 200 years.
Ares Valve has been guaranteed to reach up to 2,000,000 cycles.



very compact
really fast



Hummingbird: time of wing opening / closing: up to 0,01”
VIP Valve (DN10): time of valve opening / closing: up to 0,03”



8 MARCH
INTERNATIONAL
WOMEN'S DAY



HAPPY **EASTER!**



OMAL will be closed for **EASTER HOLIDAYS**
from **MARCH 30th** till **APRIL the 2nd.**



ADV > ADV in 2018 focused on the claim: “Empowered Performance” and on the fact that “Thanks to the empowered performance of OMAL products, you won’t need to worry, even in the most adverse conditions”. The message we want to give is that OMAL products have features that ensure excellent performance even in extreme conditions. The ADV was adapted to the kind of trade fair in progress. For instance, for the LPG Forum in Houston the ADV graphic design referred to the famous quote “Houston, do we have a problem?”, to which the answer was: “Thanks to the empowered performance of OMAL products, you won’t need to worry even in the most adverse conditions”.

OMAL APP > we have developed an APP for smart-phone and tablet, available for iOS and Android devices. In this APP, it is possible to find the entire catalogue of OMAL products and set up your product with the valve and actuator desired. Authorized users, who have received a password from the company, may also check the price of all items, see and download their 3D videos, and create a kind of personal shopping cart that can be sent to OMAL back-office. In this sense, then, the App is a very useful tool for OMAL sales network, to see prices and place orders, available in English and Italian.

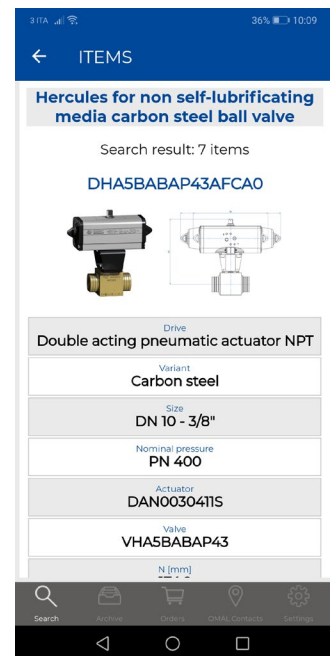

MAGAZINES > in 2018 the main technical magazines that spoke about OMAL were: CMI, Valve World Calendar, Vendor List Valve World. Many articles were then included in the magazines of some OMAL suppliers.

OMAL
AUTOMATION

EMPOWERED PERFORMANCE

BALL VALVES
BUTTERFLY VALVES
PNEUMATIC VALVES
PNEUMATIC ACTUATORS
ELECTRIC ACTUATORS

www.omal.it

OMAL S.p.A. @ Valve World Calendar



MASTER THE HURRICANE

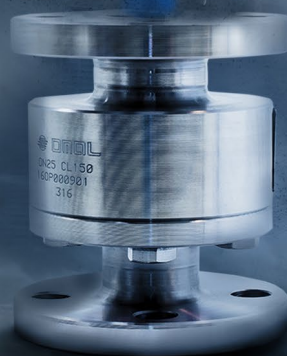

THANKS TO THE **EMPOWERED PERFORMANCE** OF OMAL PRODUCTS, YOU WON'T NEED TO WORRY EVEN IN THE MOST **ADVERSE CONDITIONS.**



3D IMMERSIVE VIDEO > the company has realized a 3D video in virtual reality that is a true journey of discovery into OMAL products. The video was prepared for trade fairs, where we also arranged a 3D station with viewers and sensors. In the video, visitors are accompanied into three OMAL products: VIP, ARES and PROCHEMIE valves. This all-round tour allows viewers to understand the added value of our products, catching design and functional details of excellence, thanks to the “exploded” vision of the item. The video, made for trade fairs, was also uploaded on YouTube and any user can see it in 3D in two modes: on a computer by moving around the 3D space with the mouse (i) or with a smart-phone, connecting it to a VR viewer, to enter in a real three dimensional space (ii).

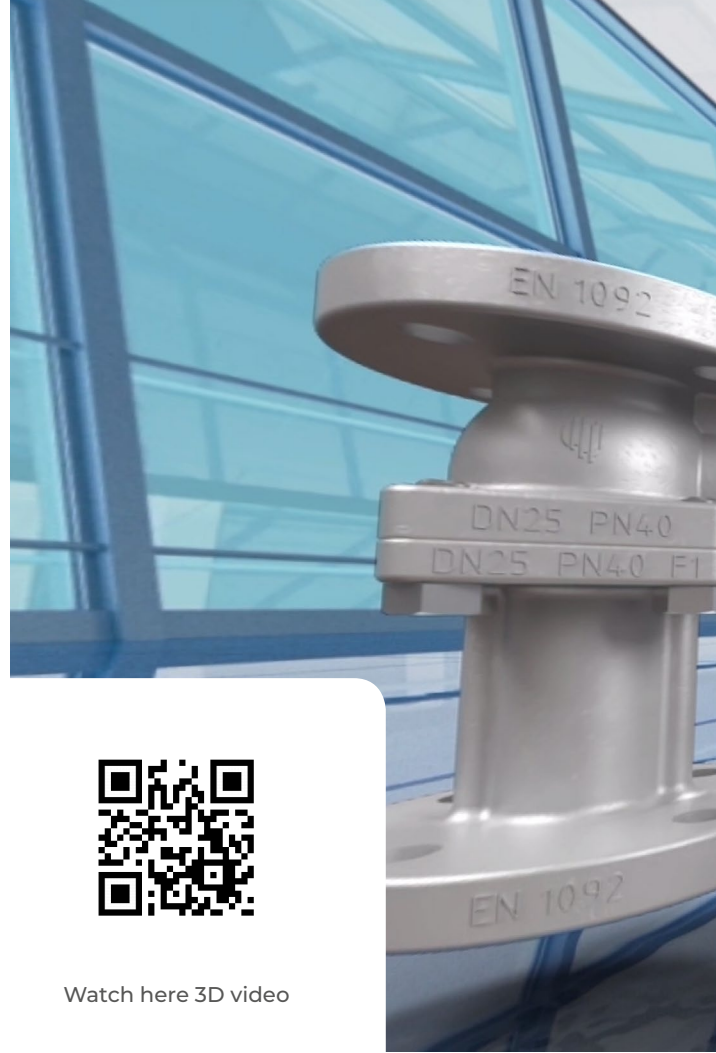

Watch here 3D video



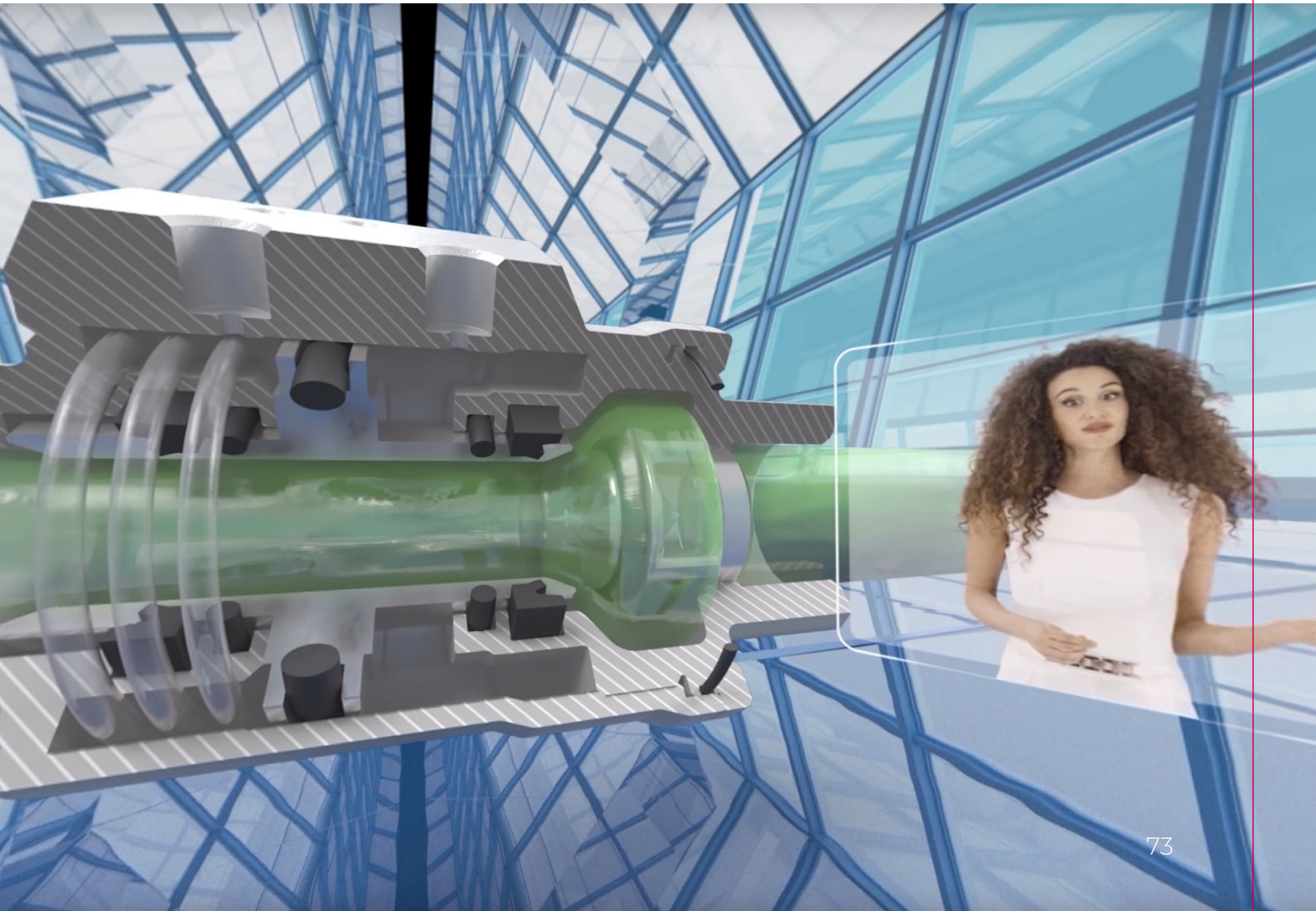

CORPORATE VIDEO 2018 > after the construction, in 2016, of the brand-new Passirano plant (new production plant) we needed to prepare a new Corporate Video to display our two Rodengo Saiano and Passirano plants. A camera crew of 9 people shot the video with boom mikes, drones, light panels... an authentic film set. In this 5 minutes video, all OMAL units are displayed: offices, administration, conference rooms, technical and quality department, assembly division and warehouse. The video is a real journey into OMAL departments, alternating shots of product details that “explode” in a game of 3D lines. The use of drones allowed us to realize amazing shots of the indoor and outdoor spaces of the two plants, surrounded by the Franciacorta greenery. The video ends with an overview of OMAL network all over the world.

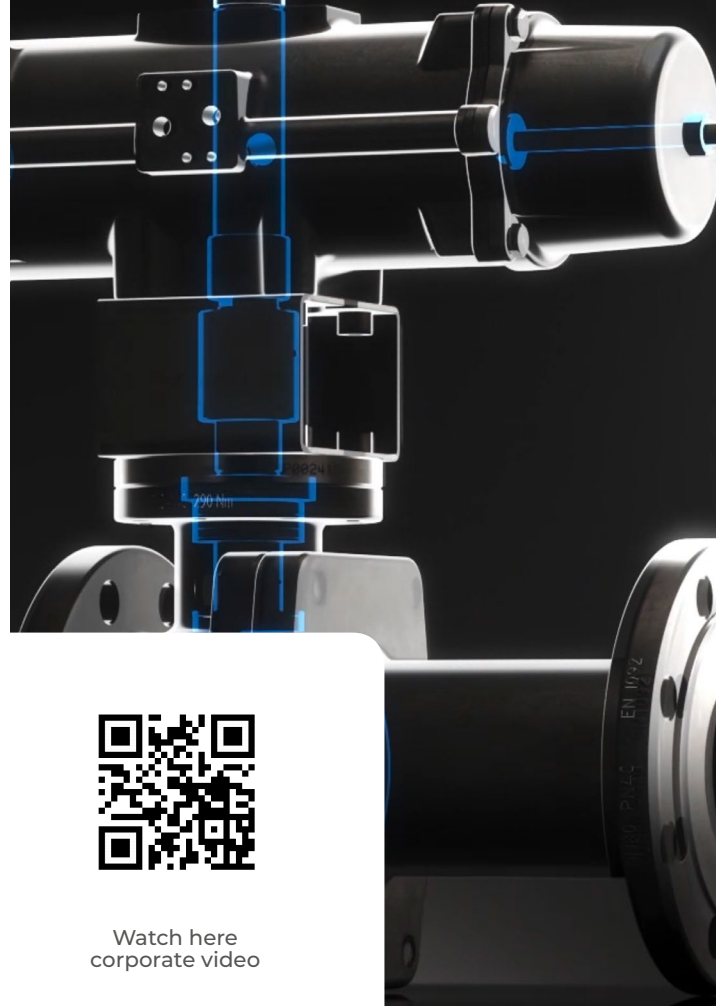

Watch here
corporate video



MAGNUM

WITH SR ACTUATOR

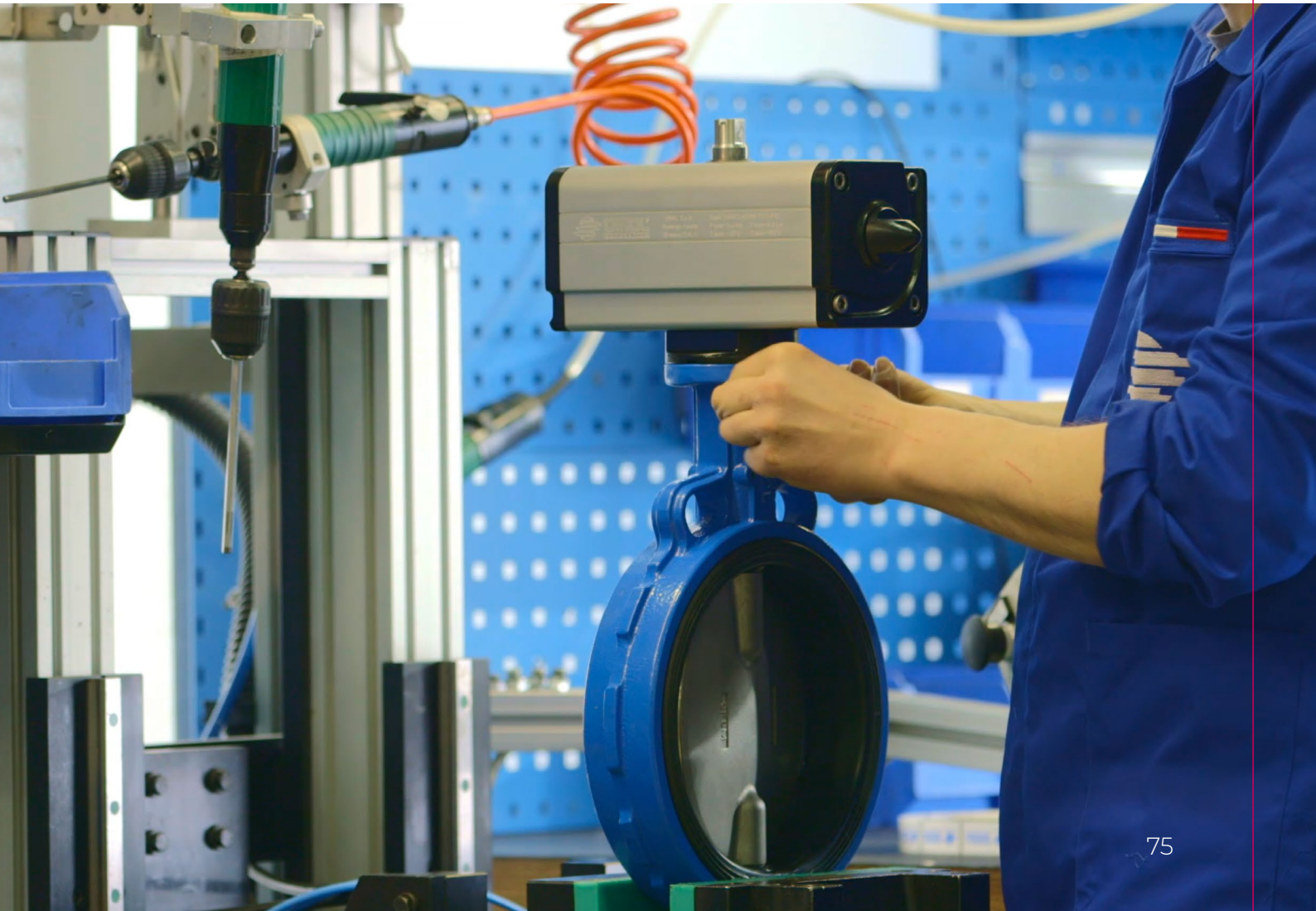





ENVIRONMENT AND QUALITY

3

3.1 RESPONSIBLE QUALITY

In 2018 OMAL continued its efforts towards “Responsible Quality”, according to which the client satisfaction can increase when the company takes a greater care of the surrounding context and environment, local communities and expectations of all those involved, internally and externally.

The Quality and Environment Management Systems, that the company have been implemented for years and are certified by ISO 9001:2015 and ISO 14001:2015 standards, ensure:

- Effectiveness and efficiency of internal processing to achieve its goals
- Continuous improvement of company performances
- Respect for the Environment, control on impacts and compliance with the law
- A management model that is dynamic, innovative and oriented towards the client satisfaction and loyalty.

The High Level Structure, that defines a common structure for the Quality and Environment Systems, ensures an increasingly greater integration with common terminology, broader sharing of internal procedures and management simplification.

The introduction of Risk Based Thinking has led us to analyze with increasing attention the context in which OMAL operates and the expectations of its stakeholders, in order to assess risk areas and opportunities for improvement.

The goal is to raise the level of the company's strategic vision, identifying internal and external factors that may influence the ability of the organization to achieve its expected results. Internal conditions or characteristics are then analyzed, i.e. personal skills, processes, products, policies and corporate culture, strategic orientation, vision and mission, as well as working environment. External factors that may affect the business include the territory where OMAL operates, environmental circumstances, local communities, social and cultural aspects, the political, economic and financial context, technological progress, market trends, local, national and international regulations.

After analyzing the context, we have identified the interested parties (employees, clients, suppliers, Institutions, regulatory bodies, partners and shareholders...), their needs and expectations on “Responsible Quality”.

The task of quality management is to define and assess risks and opportunities for improvement, according to the Risk Based Thinking philosophy, in order to contextualize all necessary actions within the company's Management System.

This approach has allowed OMAL to make decisions on the basis of an assessment of the possible positive or negative consequences of its actions. An ad hoc operational procedure provides a method to determine, assess (analysis and weighting) and treat risks and opportunities connected to the company processes, in order to:

- Ensure the effectiveness of the Integrated Management System
- Prevent or reduce unwanted or unexpected effects
- Increase the effectiveness of the Management System
- Achieve the continuous improvement

The risk management of unwanted or unexpected effects on the operability of the Management System (e.g. risks connected to deliveries to clients and product conformity) is conducted by giving risks a priority index and then implementing mitigation or improvement actions and contingency plans.

The risk analysis is carried out daily by the general Management and the Process Supervisors during the stages of strategic and operational management of the organization. The risk-management matrix is re-assessed and, if needed, updated at least every 6 months, during the Management Review activities, whose "Risk Analysis" is an integral part, or when a substantial organizational change requires to assess its risks.

3.2 QUALITY OF RAW MATERIALS

The quality of a company can be measured also by the attention given to the choice of raw materials. The selection of the materials needed to manufacture valves and actuators has the utmost importance when you want to offer high-performance and reliable products. The definition of strict procedures to select qualified suppliers and high-quality input materials allow to track every production step and work metals and plastics in a highly controlled and performing way.

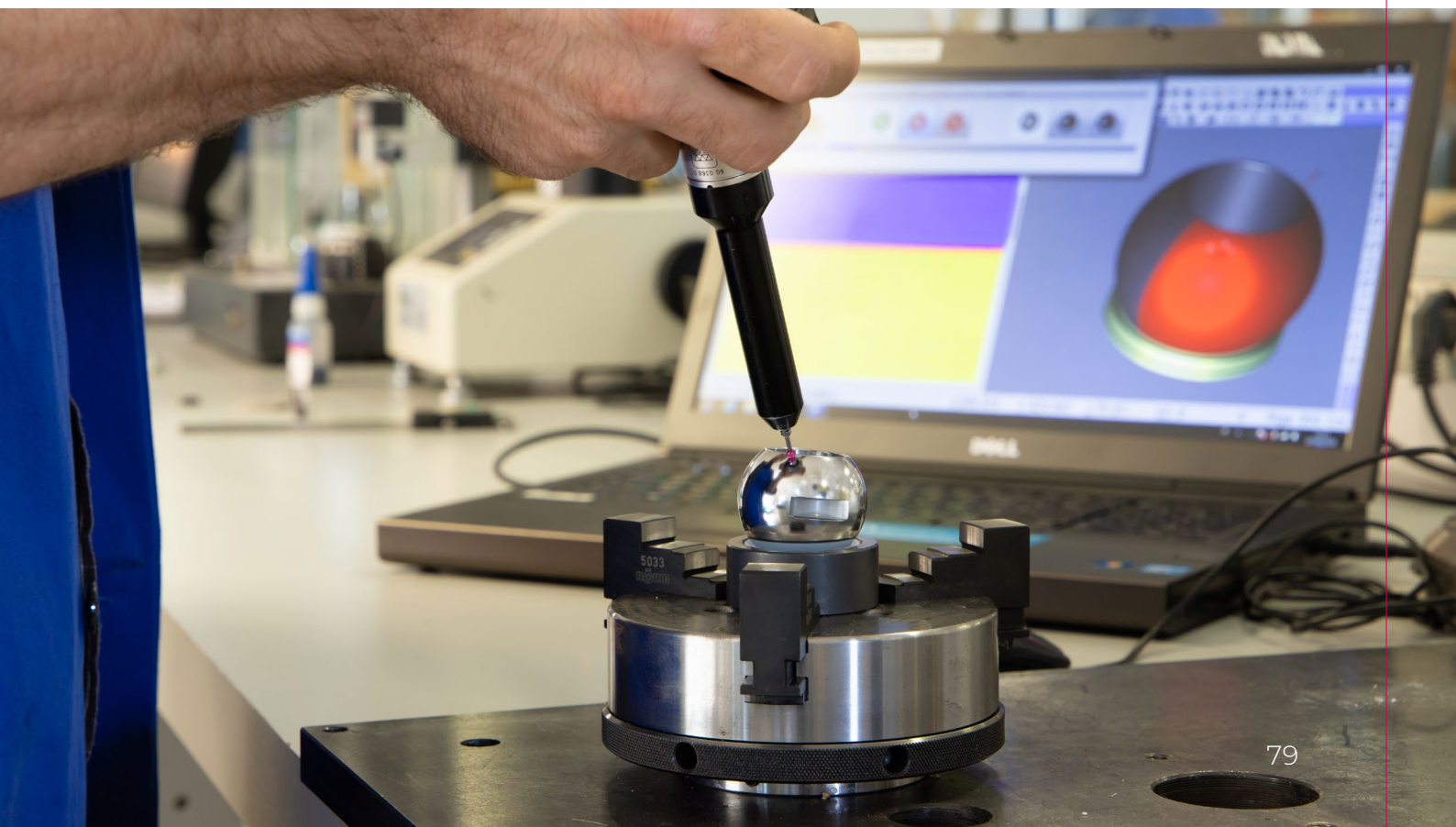

3.3 RESPECT FOR THE ENVIRONMENT

The protection and commitment of OMAL towards the Environment symbolize an intrinsic value in the way we do business, an incentive for continuous improvement and innovation and a value shared by every single unit. The commitment to Environment protection is sponsored and encouraged by the general Management and is extended to the entire organizational context, driving everyone's daily actions towards:

- using resources in a sustainable way;
- finding measures to reduce climate change and prevent pollution;
- minimizing waste production by facilitating the recovery and/or recycling of materials from an economic viewpoint;
- identifying the relevant environmental aspects in terms of product life-cycle (from its design to the supply of raw materials, production, delivery and end-of-life);
- improving internal and external communication to promote a sustainability-oriented work culture.

In this perspective, throughout 2018, **OMAL Environmental Policy** was updated (see annex), pointing out that only *“the right balance between man and environment improves the quality of life and ensures a better world for future generations. The Mission that we respect every day makes us credible and reliable actors because, with our production of valves and actuators, we protect the environment and the community around us, tangibly improving the quality of life and making our plants safer and more reliable”*.

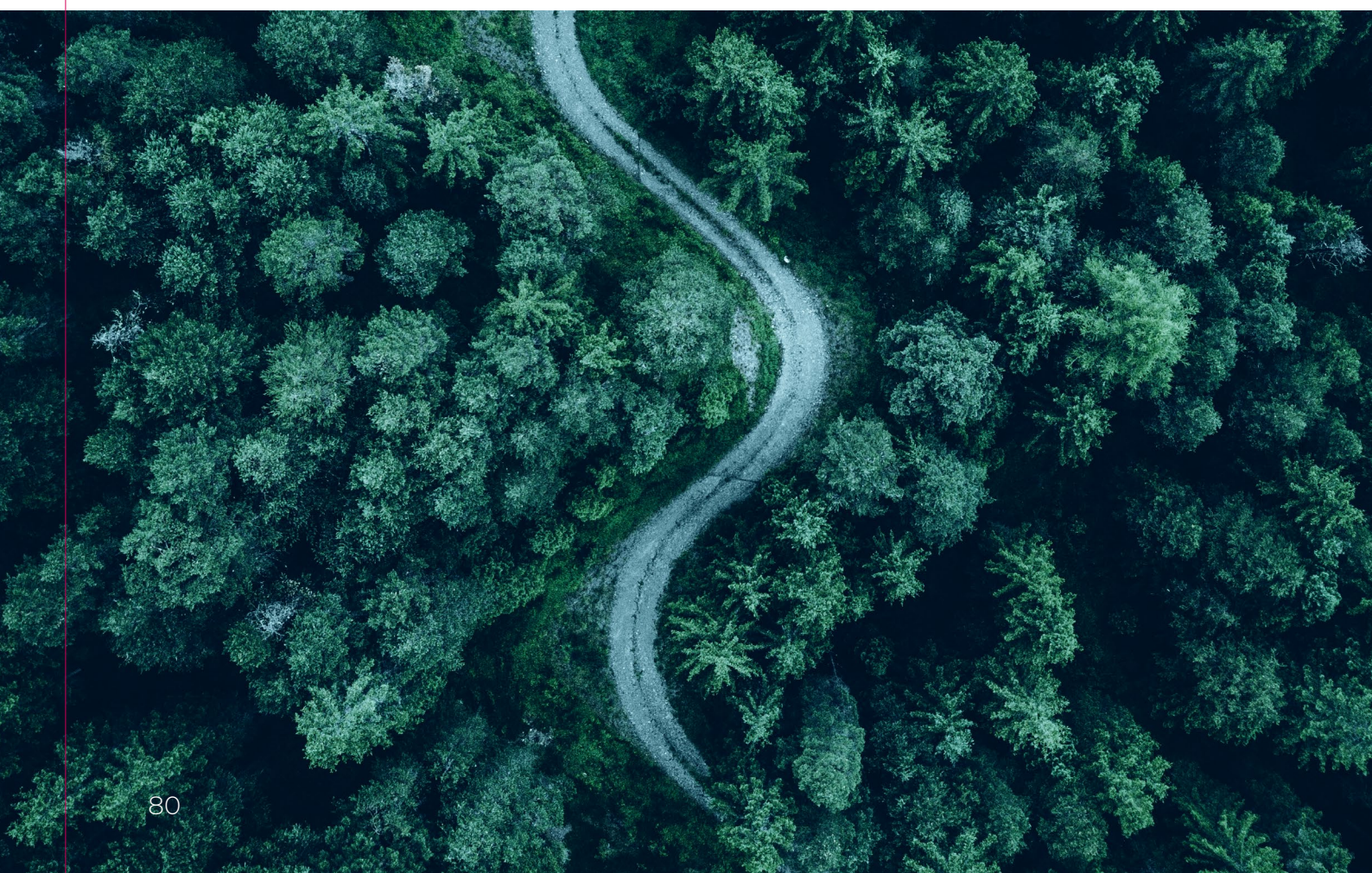

In November 2018, OMAL approved a **Green Procurement Policy** (see annex), by which *“is committed to identify and manage all social and environmental impacts related to the production and sale of industrial valves and actuators, including those deriving from the supply of products and services, by directly engaging its supply chain.”*

Selection criteria have been subsequently determined to guide the Purchasing department in the selection of new suppliers, also according to their environmental and social performances.



The goal of our Green Procurement Policy is to select our suppliers on the basis of their environmental and social performances, rewarding the most virtuous ones with a higher rating and making our Supply Chain aware of our objectives of:

- Reducing waste (by reducing consumption or re-using, recovering or recycling raw materials/ packaging...);
- Optimizing the procurement processes (e.g. GREEN IN Program, measurement and compensation of CO₂ emissions from inbound logistics);
- Promoting virtuous behaviors inside and outside the organization;
- Monitoring our suppliers environmental performances;
- Sharing our Policy with the supply chain.

3.4 DISTINCTIONS FOR OUR COMMITMENT IN SAFEGUARDING THE ENVIRONMENT

In 2018, OMAL commitment to the environment was acknowledged by: **ecovadis**

**ECOVADIS:
SUSTAINABILITY
RATING
GOLD**



We have been awarded with a “GOLD” medal for our sustainable performance by the EcoVadis platform, that allows member companies to monitor their performance sustainability and present the results to their clients, strengthening the awareness to be able to count on a supplier that, in a transparent and verified manner, is publicly committed to improve CSR and quality processing. The assessment score of OMAL environmental performance has increased from 63 points in 2017 to the actual 70 points, placing it in the **top 5% rank of all the companies assessed by EcoVadis for the production of machines for general use.**

CERTIFICATIONS & ENDORSEMENTS

- ✓ At least one site is ISO 14001 certified
- ✓ Global Compact Signatory

CSR PERFORMANCE OVERVIEW

Score breakdown

OMAL SPA CSR performance is: **Advanced**

CSR Performance ● Insufficient ● Partial ● Moderate ● Advanced ● Outstanding

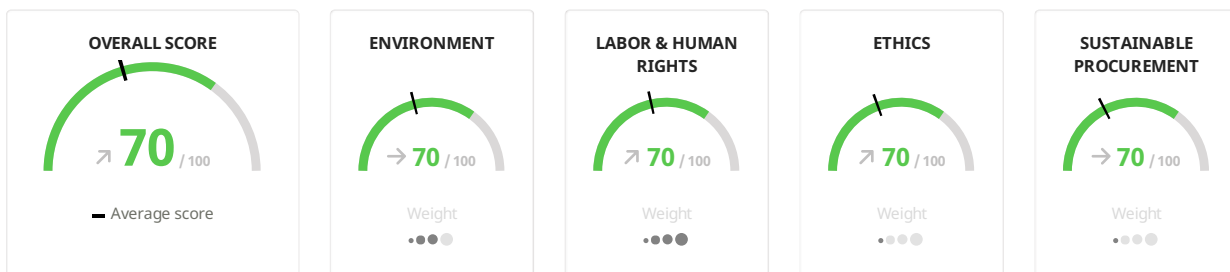

Overall score distribution

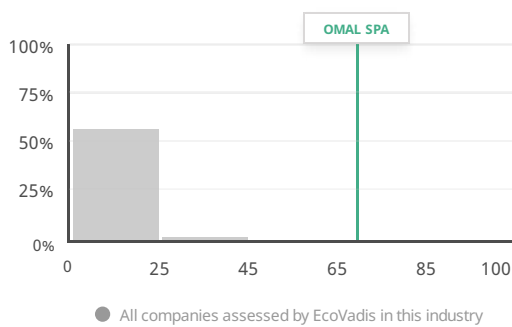

Theme score comparison

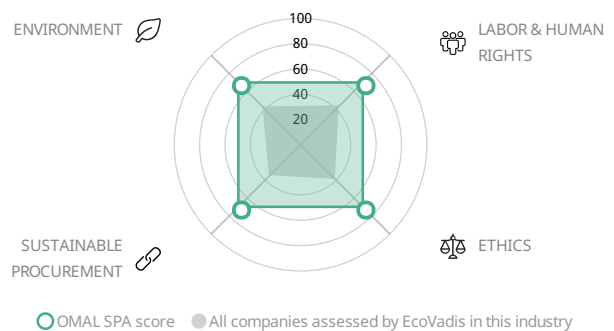

3. ENVIRONMENT AND QUALITY

Our strong points have been:

Policies

- Environmental policy on relevant issues (e.g. energy consumption and greenhouse gas emissions, waste...)
- Adhesion to Global Compact

Actions

- Formalized procedure for the management of materials/chemical products (e.g. storing, handling, transport...);
- Formalized procedure for local and accidental pollution, noise and/or smell;
- Formalized procedure for water management;
- Execution of energy audits or carbon footprint assessments;
- Supply of specific information about the product end-of-life to clients;
- Employee awareness or other training programs on transportation of hazardous materials;
- Measures to ensure compliance with ADR regulations on the transport of dangerous goods;
- Eco-design measures to improve the energy performance of the building;
- Reduction of energy consumption thanks to innovative technologies;
- Adhesion to an official program to compensate CO₂ emissions;
- Use of renewable energy and purchase of green energy;
- Specific procedure to manage emergencies;
- Actions to detect and remove groundwater contamination;
- Packaging designed to facilitate disassembly and easy recyclability;
- Measures to re-use or recycle waste;
- Implementation of measures to reduce pollutants discharged into water;
- Implementation of measures to handle waste and treat hazardous substances;
- Implementation of a Certified Management System according to ISO 14001 standard on more than 81% of the operational sites;

Results

- Reporting on CO₂ direct emissions
- Reporting on fossil fuel energy consumption
- The CSR report follows the GRI guidelines
- Reporting on electricity power consumption

B CORP AWARD: “BEST FOR THE WORLD 2018”

In the annual B Corp congress, that took place in Bologna on the 28/11/18, OMAL has been awarded for its commitment to the Environment. In the Benefit Impact Assessment it obtained a score, for the ENVIRONMENT section, of more than **10 percentage points above the B Corp world average**. This important acknowledgment for our commitment to the Environment has been given to only 11 Italian companies and, **on a global level, OMAL has been the only company of the Industry section to qualify in its product category: building materials.**

M | B | Follow | Sign in | Get started

VOTE EVERY DAY | B CORPS | IMPACT | INCLUSIVE ECONOMY | CLIMATE CHANGE | BEST FOR THE WORLD | NEWSLETTERS | Q

705



2018 Best For The World Honorees List

Scroll down through the alphabetical list of all Best For The World 2018 honorees below. You can also search for a specific company, award category or location using the search bar, and click on the column headers to sort each column. Scroll to the right to find links to each honoree’s B Corp profile page.

environment

| Company | Award Category | Industry | Country | State/Province | B Corp |
|----------------------|----------------------|--------------------------------------|----------------|-----------------|------------|
| OMAL S.p.A | Environment | Building Materials | Italy | Brescia | https |
| Once Upon a Farm LLC | Environment | Food & Beverage | United States | California | https farm |
| Ondulé | Environment | Sports Equipment, Toys & Accessories | Argentina | Cordoba | www |
| One Nature LLC | Environment | Architecture/Design/Planning | United States | New York | https LLC |
| OORR | Environment | Apparel, Footwear & Accessories | Australia | New South Wales | https |
| Organicos Brita | Overall; Environment | Agricultural Services | Chile | Bio Bio | https |
| Ossa Organic | Environment | Food & Beverage | United Kingdom | London | https |
| Palto | Environment | Office Products & Printing | United States | California | https |

OMAL environmental commitment and goals have been translated into the following concrete actions, divided in GREEN IN (OMAL upstream activities and processes) and GREEN US (internal activities and processes).

3.5 GREEN IN

1. SUSTAINABLE SUPPLY CHAIN

In 2016 OMAL started for its supply chain an awareness program on the subjects of corporate social responsibility and respect of environmental standards, involving a sample-group of 17 companies.

In 2018 the suppliers that have read our Supplier Code of Conduct were 164 out of 188 and 60% of them responded positively by signing the document.

The implementation of selection criteria also on the basis of the compliance with the company's policies and goals on environmental issues represent a reduction of overall risks for OMAL.

OMAL suppliers were therefore divided by their kind of supply:

DISTRIBUTION BY KIND OF SUPPLY

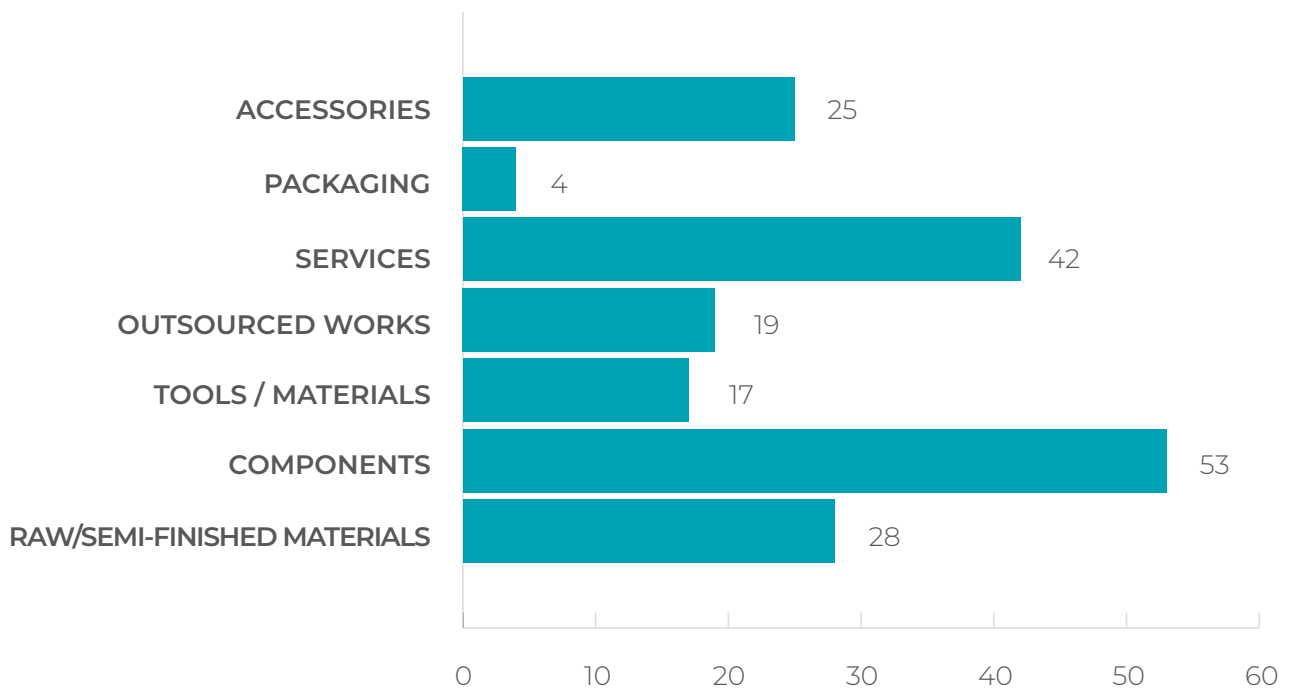

The geographic location of the suppliers and their proximity to OMAL production plants are an important selection criteria, with significant consequences also on the environment and the impacts of inbound logistics.

Geographically, purchases are divided as follows:

SUPPLIERS DIVISION BY GEOGRAPHICAL ORIGIN

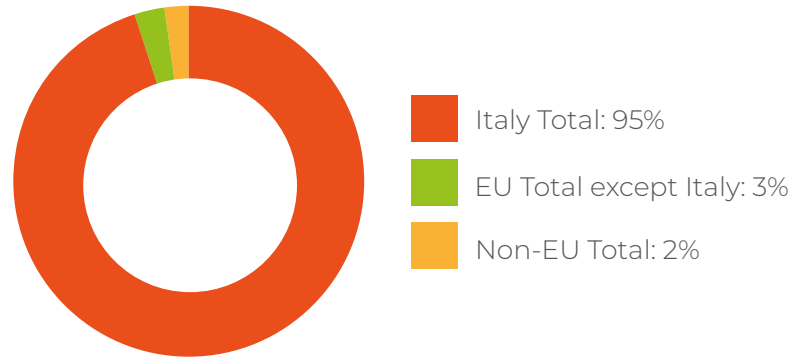

Where Italy accounts for 84%.

Observing the distribution of suppliers in Italy, on the basis of the turnover, 90,10% is located in Lombardy with 95,5% of them in the provinces of Brescia, Bergamo and Milan only.

DISTRIBUTION OF SUPPLIERS IN LOMBARDY

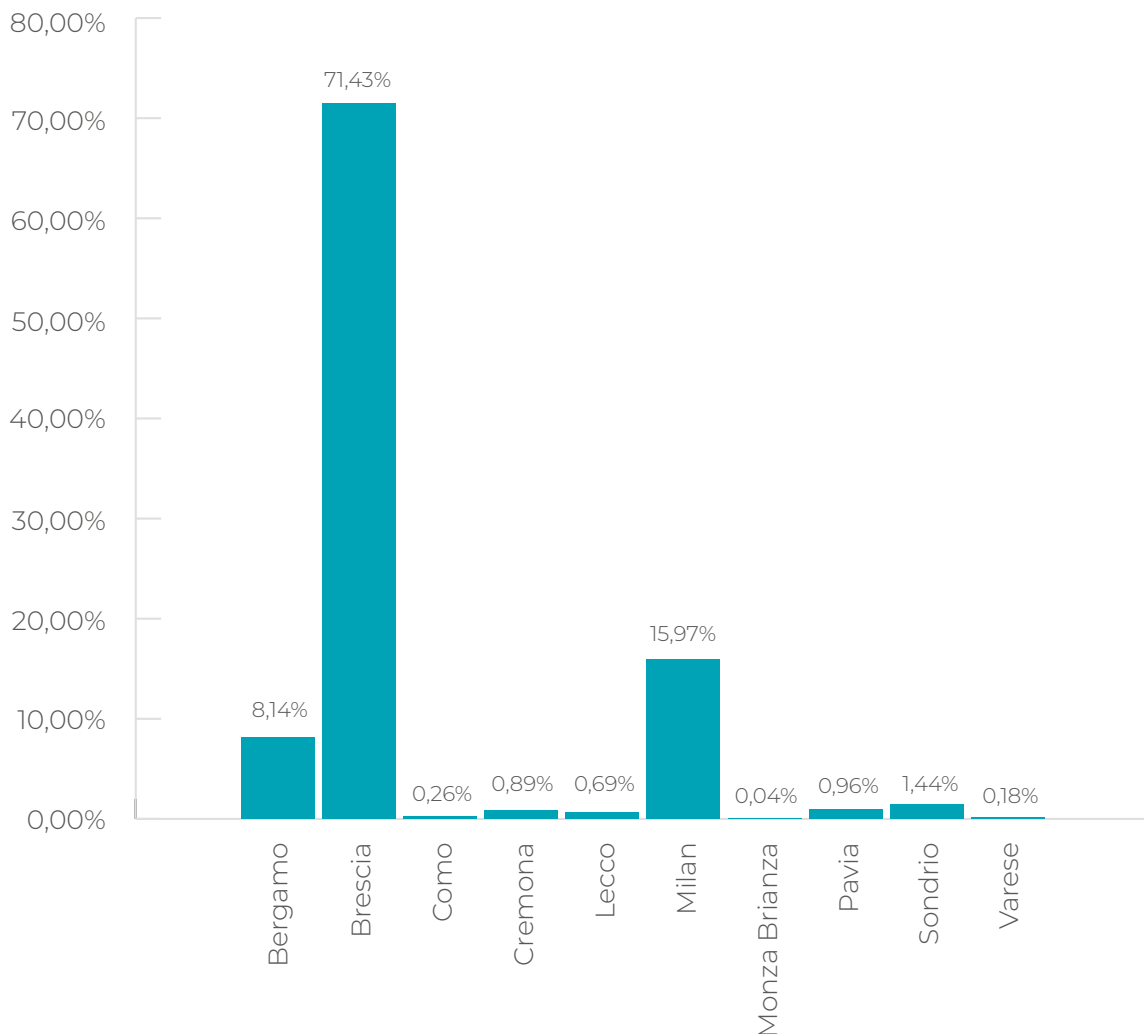

We can therefore conclude that about 88% of suppliers are located at an average distance of less than 200 km.

AVERAGE DISTANCE OF SUPPLIERS

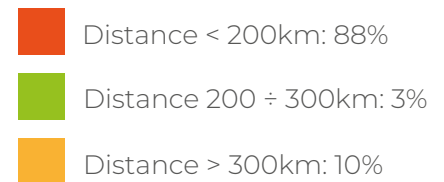
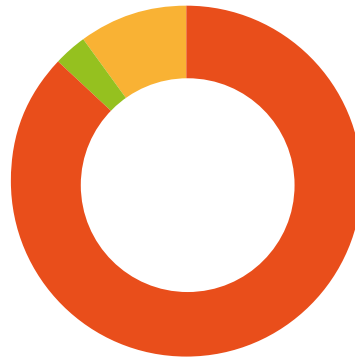

2. OFFSET OF EMISSIONS LINKED TO INBOUND LOGISTICS

OMAL has been participating to a series of projects to quantify and offset CO₂ emissions linked to inbound transport, outsourced to three main logistic partners: Aprile Spa, Shenker Italia Spa and DHL Express, that constitute 89% of OMAL logistics.

APRILE Spa has quantified the emissions connected to the transports made on behalf of OMAL by road, sea or airplane, in 135 tons of CO₂eq (calculation made according to the IPPC GWP 100 method). It has also purchased the same amount of emission credits on the VER voluntary market deriving from the program “Production of electric power with landfill gas in China”, that recovers gases spontaneously generated by solid urban waste of the landfill of the city of Xinyang. The project has generated the following environmental and social benefits:

- Reduction of GHG emissions
- Reduction of H₂S hydrogen sulfide emissions
- Better quality of life for local population
- Increased safety in the landfill
- Increase of the number of jobs for locals

ATTESTATO DI COMPENSAZIONE DELLE EMISSIONI

| | |
|--|---|
| CLIENTE Omal Spa | OGGETTO Trasporti in nave, in aereo e su strada |
| TONNELLATE DI CO₂eq 135 | PROGETTO Produzione di energia rinnovabile |
| DATA 2018 | NUMERO DI SERIE 65-OMAL-2018/OMAL-18-0/135/YMD-12-UOK |



Sandro Scollato
Amministratore Delegato AzzeroCO₂





il clima nelle nostre mani

SCHENKER has quantified the emissions connected to the transports made on behalf of OMAL in 2018 in 93 tons of CO₂eq. OMAL has voluntarily chosen to participate in the offset program SCG Biomass to Energy Project in Thailand, by recovering biomass energy produced in Thailand. This project has allowed to build a biomass plant fueled by local agricultural waste for the production of the energy needed by a cement factory. Before, the biomass was treated as waste and burnt in the fields, with considerable impacts on air quality.

OMAL has been participating for some years to the DHL project: GoGreen Climate Neutral that allows to measure the carbon monoxide emissions connected to their deliveries and to directly pay the offset for the delivery by investing in climate protection projects. The amount of OMAL contribution to the GoGreen project in 2018 was € 4.147,25. Every year DHL provides a certificate that details the total amount of CO₂ produced and the credits used to finance the selected projects, that help local communities. At the time of the publication of this report, the certificate hasn't been available yet, but it is hereby attached the one of last year.

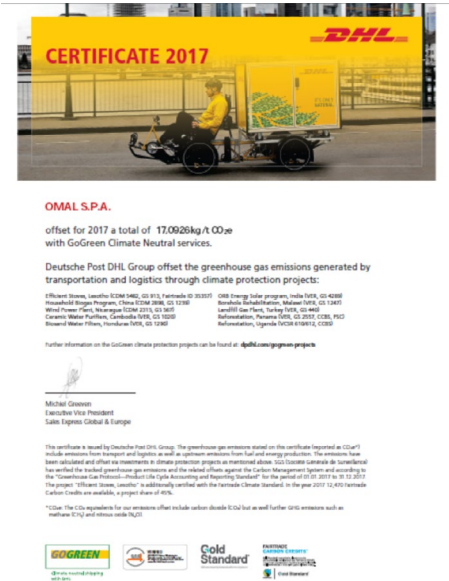

As happened in 2017, OMAL will directly compensate the remaining emissions connected to inbound logistics by buying VERs during 2019.

3. GREEN SUPPLY CHAIN, CIRCULAR ECONOMY AND WASTE REDUCTION

With Green Supply Chain we mean a management approach that aims at minimizing the environmental impacts of our products throughout their entire life-cycle, from material procurement to end-of-life and final disposal. The attention focus moves then from OMAL as single company to the whole system of relations and actors that participate in creating a value. The relation with the environment subsequently moves from the company boundaries to the relations between different clients and suppliers, considering “enlarged management models” that can reduce overall impacts by engaging all the chain actors, creating a sustainable value for stakeholders and minimizing inefficiencies and risks. In this perspective, we have implemented the following main actions:

- changing in length of aluminum profiles to optimize the cutting stage for suppliers and reduce production waste;
- sending metal waste of OMAL works to the raw material suppliers in a circular economy perspective, to create a virtuous flow;
- redefining supply chain relations for the procurement of aluminum and brass.

In particular, OMAL started a virtuous path for the management of aluminum and brass, in a circular economy perspective. It decided to buy these materials from suppliers that also take back production waste. Such a choice allows to have raw materials at “reduced impact”, because the cost in environmental terms is only due to the transformation of waste into new materials to be reintroduced into OMAL production cycle. All of this was made possible thanks to our Actuatech subsidiary, because the aluminum waste is transformed into aluminum alloy breads that are used by Actuatech in the die-casting process necessary for manufacturing semi-finished products then bought by OMAL. OMAL started a process to extend this mechanism to all its subcontractors, implementing with them a framework agreement that requires them to give back mechanical production waste to the same supplier that sold them the raw materials.

3.6 GREEN US

CARBON FOOTPRINT

Minimizing environmental impacts is a challenge that OMAL started in 2016 with the choice of quantifying the carbon footprint of the organization and so having a first estimate of its performance in terms of resources consumption, atmospheric emissions, waste production and water discharges. The study has been replicated on the 2018 final data, to analyze the changes occurred and quantify the benefits obtained by the implementation of measures aimed at reducing CO₂eq emissions.

The Corporate Carbon Footprint is an index to measure the impact of corporate activities on GHG (Green House Gases) emissions, that are primarily responsible for the greenhouse gas phenomenon, converting them in tons of carbon dioxide equivalent (CO₂eq). It is a clear, concise and easily understandable index, also for those who do not have a technical-scientific background sufficient to assess the results of the low carbon policies implemented.

The study was carried out by 2A ECOGESTIONI Srl according to the provisions of UNI EN ISO 14064:2012 standard, collecting data related to OMAL plants in Passirano (BS) and Rodengo Saiano (BS) in the period between January 1st – December 31st 2018. According to the GHG Protocol, the emissions were recorded distinguishing between Scope 1, Scope 2 and Scope 3, as follows:

1 SCOPE 1: direct emissions

These are GHG direct emissions originating from the plants inside the organization's boundaries, as, for instance, emissions originating from the direct burning of fossil fuels or the consumption of fuels for vehicles owned by the company. Fluorinated greenhouse gases from refrigeration and conditioning plants installed in the company's facilities are also included in this category.

2 SCOPE 2: indirect emissions from energy consumption

These are GHG indirect emissions originating from electricity, heating and steam, because the importer is indirectly responsible for the emissions created by the supplier to produce the energy required.

3 SCOPE 3: other indirect emissions

These are the emissions connected to the manufacturing and supply of products and services used by the organization, as, for instance, emissions originating from the production (and transport) of raw, packaging or auxiliary materials, waste treatment, delivery of finished products and the end-of-life of products and their packaging. In this Scope 3 category are also included GHG emissions connected to the fuel supply chain and emissions originating from power losses in the transmission of the energy consumed by the organization.



According to the ISO 14064 standard, Scope 1 and 2 must be mandatorily accounted for, while Scope 3 is discretionary. As in the past, OMAL chose to extend the study also to “other indirect emissions” in order to have an overall and representative assessment of OMAL as a company and its activities. As illustrated in the chart above, the processes considered range from raw material procurement to distribution of final products, namely from upstream to downstream activities, passing by core activities (in the company).

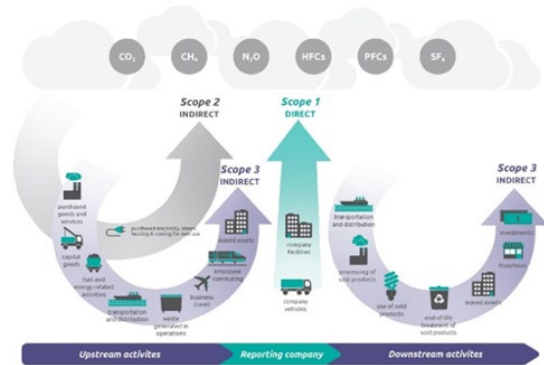

The table below shows the results of the Carbon Footprint study for 2018:

| GHG Protocol | UNI EN ISO 14064 – 1 - year 2018 | GHG Emission [tCO ₂ eq] |
|--------------|--|------------------------------------|
| Scope 1 | Direct Emissions | 191,01 |
| Scope 2 | Indirect emissions from energy consumption | 217,94 |
| Scope 3 | Other indirect emissions | 10.028,91 |
| Total | | 10.437,85 |

GHG EMISSION RESULTS YEAR 2018

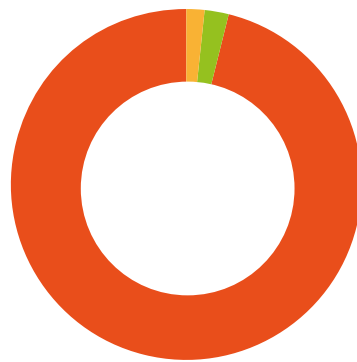

- Scope 1: 1,8%
- Scope 2: 2,1%
- Scope 3: 96,1%

As shown in the table and chart, Scope 3 (other indirect emissions) has the highest incidence on the total emissions originated from OMAL in 2018. Such an aspect is mainly due to the manufacturing and transport processes of raw materials (steel, aluminum, brass and bronze) used in the production process and therefore fundamental for the company.

As seen before, the actions implemented by OMAL to limit this aspect are:

- Selecting suppliers located within a 200 km radius from the company, in order to reduce transport incidence;
- Wherever possible, giving back waste materials of mechanical handling (chips, chunks or non-conform pieces) to the same supplier.

COMPARISON OF CARBON FOOTPRINT RESULTS YEARS 2016 - 2018

Comparing the 2018 data with those obtained from the 2016 carbon footprint study, we can notice how much the company’s reality has changed, even if the overall data has remained in the same order of magnitude.

3. ENVIRONMENT AND QUALITY

| GHG Protocol | UNI EN ISO 14064 – 1 | GHG Emissions 2016 [tCO ₂ eq] | GHG Emissions 2018 [tCO ₂ eq] | Variation [%] |
|--------------|--|--|--|---------------|
| Scope 1 | Direct Emissions | 684,48 | 191,01 | -72,09% |
| Scope 2 | Indirect emissions from energy consumption | 1.047,67 | 217,94 | -79,20% |
| Scope 3 | Other indirect emissions | 8.499,32 | 10.028,91 | +18,00% |
| Total | | 10.231,48 | 10.437,85 | +2,02% |

GHG EMISSIONS COMPARISON YEAR 2016 - 2018

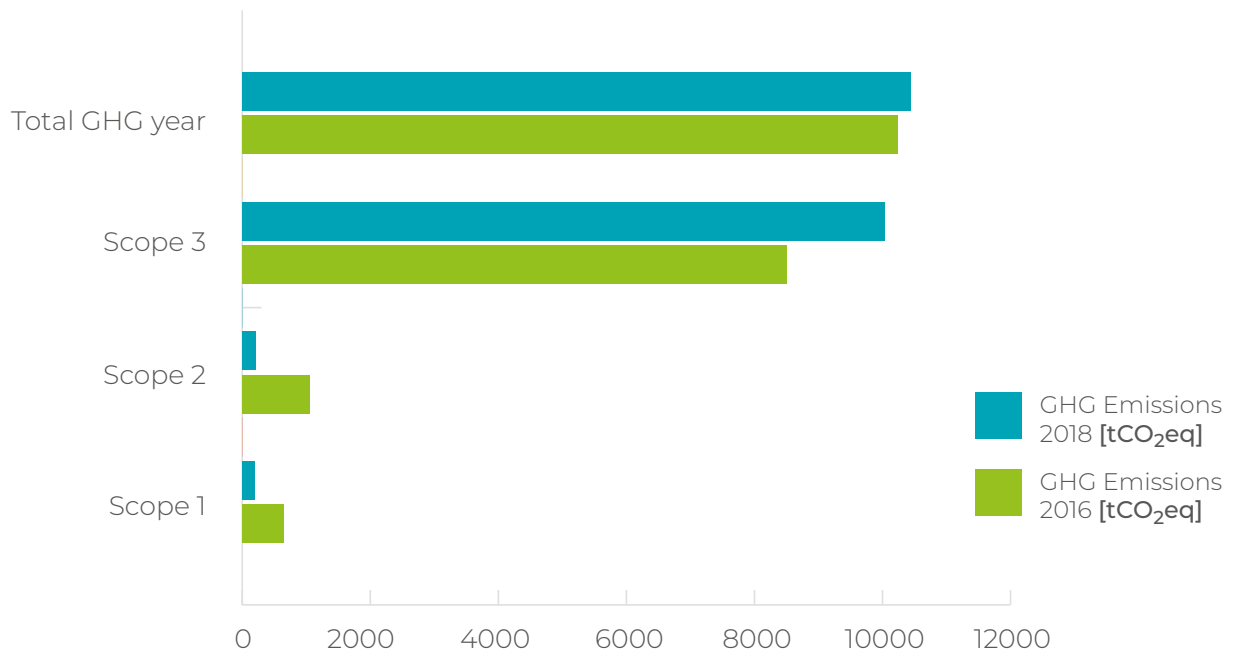

The main changes occurred between the two studies are the reduction of direct emissions (Scope 1) and indirect emissions from energy consumption (Scope 2). The reasons for such changes are:

- **SCOPE 1:** production and consumption of methane gas caused by the reduction of natural gas consumption, because die-casting and painting activities, once managed by OMAL, are now carried out by Actuatech SpA in the Villa Carcina (BS) plant. The reduction in terms of CO₂eq due to this aspect is around 79%.
- **SCOPE 2:** OMAL decision of using only energy from renewable sources has resulted in a CO₂eq saving of about 79,2% compared to 2016 (in 2016 the energy mix was made by only 45% from renewable sources).

As far as concerns the growth of other indirect emissions (Scope 3), the +18% increase is caused by the purchasing of raw materials with a bigger intrinsic environmental impact (special steel alloys and new copper alloys), because the market increasingly requires items made with these more performing materials for some specific valves.

Another energetic strategy implemented by OMAL was the installation of a new photovoltaic plant that last year produced 109.556,00 kWh for self-consumption. This allowed to save 37.158,76 kg of CO₂eq (emissions originating from the production of the same quantity of electric power in the national energy mix).

The calculation of OMAL GHG emissions, carried out in conformity with UNI EN ISO 14064-1 standard, has been verified by DNV-GL and the verification was carried out in conformity with UNI EN ISO 14064-3 standard, as illustrated in the certificate released by the Certification Body.

DNV·GL

GREEN HOUSE GAS INVENTORY (GHGI) VERIFICATION STATEMENT

Attestato No.:
284683-2019-E-ITA-RvA

Data prima emissione:
28 febbraio 2019

Validità:
28 febbraio 2019 - 28 febbraio 2020

DNV Business Assurance ha verificato, in conformità alla norma ISO 14064-3, che definisce specifiche e fornisce una guida per la verifica delle asserzioni riguardanti i gas a effetto serra (di seguito GHG), l'asserzione GHG emessa in data 21 Febbraio 2019 emessa da

OMAL S.p.A.

Via Ponte Nuovo, 11 - 25050 Rodengo-Saiano (BS) - Italia

riportati nel documento interno intitolato "Report CFO OMAL SpA_2018_Rev. 01", relativa all'inventario dei gas serra dei 2 siti del Gruppo elencati in allegato a questa dichiarazione.

DNV GL afferma che gli indicatori di gas serra riportati nel documento di cui sopra forniscono una rappresentazione affidabile ed equilibrata dell'inventario dei gas serra entro i confini di seguito definiti e calcolati in conformità con lo standard aziendale "Report CFO OMAL SpA_2018_Rev. 01", con i risultati seguenti (valori arrotondati al kg):

| EMISSIONI GHG 2018 | t CO ₂ -eq | | | | | | TOT. GHG |
|--|-----------------------|-----------------|------------------|-------------|-------------|-----------------|-----------------|
| | CO ₂ | CH ₄ | N ₂ O | HFC | PFC | SF ₆ | |
| TOTALI | | | | | | | |
| 1. TOTALE EMISSIONI DIRETTE (SCOPE 1) | 189,11 | 2,13 | 0,64 | 0,00 | 0,00 | 0,00 | 191,88 |
| 1.1 DA COMBUSTIONE | 125,68 | 1,15 | 0,00 | 0,00 | 0,00 | 0,00 | 126,83 |
| 1.2 DA MACCHINE AZIENDALI E MOV. INTERNA | 63,43 | 0,98 | 0,64 | 0,00 | 0,00 | 0,00 | 63,43 |
| 2. EMISSIONI INDIRETTE ENERGETICHE (SCOPE 2) | 217,94 | 0,00 | 0,00 | 0,00 | 0,00 | 0,00 | 217,94 |
| 2.1 DA CONSUMO DI ENERGIA ELETTRICA | 217,94 | N.D. | N.D. | N.D. | N.D. | N.D. | 217,94 |
| 3. TOTALE ALTRE EMISSIONI INDIRETTE (SCOPE 3) | 10028,61 | 0,00 | 0,00 | 0,00 | 0,00 | 0,00 | 10028,61 |
| 3.1 PERDITE E TRASFORMAZIONE ENERGIA ELETTRICA | 15,51 | N.D. | N.D. | N.D. | N.D. | N.D. | 15,51 |
| 3.2 PRODUZIONE COMBUSTIBILI | 51,00 | N.D. | N.D. | N.D. | N.D. | N.D. | 51,00 |
| 3.3 PRODUZIONE E TRASPORTO ACCIAIO | 3137,95 | N.D. | N.D. | N.D. | N.D. | N.D. | 3137,95 |
| 3.4 PRODUZIONE E TRASPORTO ALLUMINIO | 1100,99 | N.D. | N.D. | N.D. | N.D. | N.D. | 1100,99 |
| 3.6 PRODUZIONE E TRASPORTO BRONZO | 93,14 | N.D. | N.D. | N.D. | N.D. | N.D. | 93,14 |
| 3.7 PRODUZIONE E TRASPORTO OTTONE | 5101,08 | N.D. | N.D. | N.D. | N.D. | N.D. | 5101,08 |
| 3.8 PRODUZIONE E TRASPORTO PLASTICA | 185,04 | N.D. | N.D. | N.D. | N.D. | N.D. | 185,04 |
| 3.9 PRODUZIONE E TRASPORTO MATERIALI PER IMBALLAGGIO | 94,61 | N.D. | N.D. | N.D. | N.D. | N.D. | 94,61 |
| 3.10 PRODUZIONE E TRASPORTO MATERIALI AUSILIARI | 9,91 | N.D. | N.D. | N.D. | N.D. | N.D. | 9,91 |
| 3.11 CONSUMO DI ACQUA PER LA PRODUZIONE | 3,17 | N.D. | N.D. | N.D. | N.D. | N.D. | 3,17 |
| 3.12 TRATTAMENTO DEI RIFIUTI E LORO CONFERIMENTO AI DES | 26,72 | N.D. | N.D. | N.D. | N.D. | N.D. | 26,72 |
| 3.13 DISTRIBUZIONE SU GOMMA DEI PRODOTTI FINITI | 147,58 | N.D. | N.D. | N.D. | N.D. | N.D. | 147,58 |
| 3.14 DISTRIBUZIONE VIA NAVE DEI PRODOTTI FINITI | 12,73 | N.D. | N.D. | N.D. | N.D. | N.D. | 12,73 |
| 3.15 FINE VITA DEGLI IMBALLAGGI DEI PRODOTTI DISTRIBUITI | 49,18 | N.D. | N.D. | N.D. | N.D. | N.D. | 49,18 |
| EMISSIONI GHG TOTALI | 10435,66 | 2,13 | 0,64 | 0,00 | 0,00 | 0,00 | 10438,43 |

Luogo e Data:
Vimercate (MB), 28 febbraio 2019



Per l'Organismo di Certificazione

Zeno Beltrami

Zeno Beltrami
Management Representative

La mancanza di rispetto delle condizioni stabilite nel contratto di certificazione può rendere la presente dichiarazione non valida
DNV GL Business Assurance Italia S.r.l. Via Energy Park, 14, 20871 Vimercate (MB), Italy. Tel: 039 68 99 905. www.dnvgl.it/assurance

by 7.268 kWh and so avoid the emission of 958 kg of CO₂eq.

- the main heating and heating recovery circuits are equipped with a system to calculate thermal energy, in order to check and monitor energy consumption.
- the management of energy consumption is ensured by a MOVICON automation system that allows us to rationalize and optimize energy consumption.

3. PASSIRANO PHOTOVOLTAIC PLANT PERFORMANCE

Within the programs to improve the environmental impacts of its production plants, OMAL has invested in the production of energy from renewable sources. In the Passirano site a photovoltaic plant has been installed, with 400 panels of 250W in 16 rows and 25 panels connected to 5 inverters of 20Kw for a total installed capacity of 100 kWp, that ensure a minimum contribution of 100.000 kwh/year of renewable energy. In 2018 the energy production was 118.122 kwh, of which 93% was used for self-consumption and 7% given to the national energy grid. This not only has prevented the CO₂eq. emissions connected to the production of such energy, but also losses related to its re-introduction into the national grid.

4. ENVIRONMENTAL AWARENESS OF OMAL STAFF

OMAL believes that important results in terms of environment can be achieved thanks to the little efforts of every single employee, whatever his/her position within the company.

To this end, it invests many resources in information/training and awareness programs on environmental issues for all internal staff.

Such commitment can be find also in the considerable reduction of mixed unsorted waste produced and disposed by the organization: mixed packaging to be disposed by the company have decreased by 73% compared to 2012, generating an increase in recyclable waste, easier to recover and with less environmental impacts.

5. WASTE MANAGEMENT

The goal of a sustainable waste management is implemented by the following actions:

- maximizing the quantity of waste that can be recovered
- reducing the incidence of hazardous waste on total waste

¹ Calculation based on the assumption that the heat recovered is produced by the air conditioning system of the Passirano (BS) site.

- decreasing the percentage of waste disposed in landfills

In 2018 the following final results were obtained:

| % waste recovered | incidence % of hazardous waste on total waste | percentage of waste disposed in landfills |
|-------------------|---|---|
| 96,8% | 4,9% | 3,2% |

6. ZERO CO₂ EMISSION WEBSITE

Web browsing, sending emails, watching videos online implicate consuming electric power, whose production generates CO₂ emissions. OMAL has taken part in the CO₂web® project of Rete Clima, that offsets CO₂ emissions created by the users access to OMAL website, according to its annual average of page views. The offset is realized with reforestation activities in Italy, as well as free environmental education programs for school students.

² Offset made by Rete Clima® from the ENEA-MSE report, through the coding of a specific emissivity coefficient in terms of CO₂eq/kWh, on the basis of the national energy mix as declared by Terna for the year 2012.

7. ZERO PAPER PROJECT

This project, started in 2012, continues with the goal of progressively reducing paper thanks to processing digitalization and computerization, use of software and Apps, as well as functionalities of the new website.

The goal for 2018 was to eliminate all paper documents by making available to the operator all information needed, from technical drawings to control plans, including the management of media files (e.g. video with assembly instructions) through a single application. Every working station is equipped with network-connected PCs, that allow to share an increasingly bigger number of information, some available through specific applications (as the Integrated Management System) others connected to the Panthera management system.

Furthermore, a correct staff training has allowed to limit prints in office, with a 6,5% decrease compared to the 2016 data.

The reduction has affected especially black-and-white prints, while there has been a worsening in the use of color prints.

8. RECOVERY AND RE-USE OF PAPER AND CARDBOARD

All paper and cardboard waste from inbound packaging is managed by OMAL in order to ensure a 100% recovery, by giving it to local recycling facilities or by recovering/re-using it through specialized companies.

In the latter case, it is possible to punctually measure and report the quantities that were recycled in the past two years as follows:

| | Year 2018 | Year 2017 |
|---|-----------|-----------|
| Recovery as EWC 15.01.01 raw material in tons | 23,9 | 24 |
| % recovery | 100% | 100% |

9. USE OF STATIONERY, RECYCLED PAPER AND/OR FSC-CERTIFIED PAPER

OMAL commitment in the procurement process is also translated into the choice of using sustainable gadgets: all pens, pencils, bags and canvas shoppers with OMAL brand name are made with recycled and certified materials. All catalogues, brochures and communication materials are printed on recycled paper. Paper consumption is strongly discouraged, as illustrated in the "Zero Paper" project, however, when it's impossible to avoid it, we exclusively use FSC-certified paper and ECOLABEL that ensures that raw materials come from forests where rigorous environmental, social and economic standards are implemented.

10. loBevo ("I-Drink") PROJECT and CANTEEN MANAGEMENT

The "loBevo" project, that prescribes the use of bulk drinks in the canteen, continues with a reduction of environmental impacts, quantified on an annual average of 5.000 meals provided by OMAL as follows:

- 180 kg reduction of waste
- 7,6 tons of goods (bottles/cans) not transported
- 280 kg of CO₂ not released into the atmosphere in relation to plastic bottles not produced
- 240 kg of oil saved with the (not) transport of goods

In addition, sorted waste collection was also extended to the corporate canteen managed by CAMST and a project to recover food surplus was started.

11. ECO-DESIGN AND PRODUCT LIFE-CYCLE ANALYSIS

OMAL products are designed not only to guarantee “Empowered Performance”, but also to reduce environmental impacts and ensure users safety.

The high automation and efficiency level of production processing also ensures a greater reliability, reducing operational and maintenance costs.

PNEUMATIC ACTUATORS

PNEUMATIC ACTUATORS FEATURES AND BENEFITS

1. Long operative life (up to 1000.000 cycles)
2. No need for maintenance when operating (no lubrication)
3. High recyclability of materials (100% recovery of metal components)
4. Functional safety guaranteed up to SIL 3

ENERGY EFFICIENCY

One of the priorities in designing actuators has been to limit the quantity of air, and therefore of energy, needed for their functioning. Thanks to the Scotch Yoke system, OMAL can ensure an important energy saving compared to other equivalent systems: up to 40% less of consumed air, with a weight/maximum torque ratio = -30% Kg/Nm.

Another fundamental aspect for energy saving is the correct dimensioning of the actuator, that OMAL can ensure because it is the manufacturer of the entire valve-actuator system. The choice of the right size of actuator for the intended use allows to minimize compressed air and therefore save energy.

VALVES

VALVES FEATURES AND BENEFITS

1. Long operative life (high cyclicity)
2. High maintainability (easy change of components)
3. High recyclability of materials (100% recovery of metal components)
4. Prevention of environmental pollution thanks to the external sealing system
5. Functional safety guaranteed up to SIL 3

RELIABILITY AND DURABILITY

OMAL ensures a greater reliability and durability of its valves, thanks to technical solutions to:

- reduce the deterioration of moving parts in order to improve product functionality;
- reduce the torque and subsequently reduce the energy needed for activation;
- guarantee the product maintainability.

The experience and know-how in manufacturing “turnkey” systems valve + actuator allow OMAL to optimize its performance and reduce waste.

ATTENTION TO THE END-OF-LIFE

OMAL products are designed in such a way that, at their end-of-life, they can be completely dismantled, separating the different materials for a correct disposal.

All OMAL products come with a manual that provides the list of the raw materials used and an exploded view of the product that indicates where these materials are and how to dispose them. The choices made by OMAL in designing its products allow to dispose materials and lubricants in the SPECIAL NON-HAZARDOUS WASTE category. This, however, on the condition that, during the use, the products had not been polluted by substances falling within the list of hazardous substances.

| LIST OF MATERIALS | | | |
|-------------------|----------------------------------|----------------|-------------------------------|
| METALS | TECHNOPOLYMERS | ELASTOMERS | PACKAGING |
| Aluminum | POM: acetal copolymer | NBR | Wood |
| Brass | PTFE: polytetrafluoroethylene | Polyurethane | Cardboard |
| Steel | | FKM/FPM | Paper |
| Bronze | | Fluorosilicone | Transparent polyethylene bags |
| | | EPDM | |

DESTINATION OF MATERIALS

- **METALS:** these materials can be sent as scrap to a transformer.
- **TECHNOPOLYMERS:** these materials can be sent to a transformer.
- **ELASTOMERS:** these materials, due to their small quantity and the fact that by the end-of-life they are contaminated by grease and metallic particles, are classified as special non-hazardous waste.
- **PACKAGING:** these materials are entirely recyclable and can be conferred to local recycling facilities.

SUSTAINABLE PACKAGING

Packaging boxes and spacers for OMAL products are made in corrugated board MARKED “Fully made with recycled paper” that ensures that the materials used for paper and cardboard is fully recycled and recyclable according to the Paper Mills Association.

External packaging, having to guarantee a greater strength and protection, are made in corrugated board with a smaller percentage of recycled material, but its end-of-life recyclability is anyway ensured in the COMIECO (Italian National Consortium for recovery and recycling) circuit.







COMMUNITY AND
BUSINESS MODEL

4

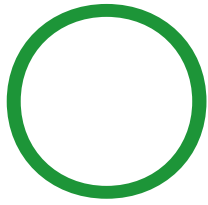

MAL keeps a constant dialogue with its local community, intended as the totality of the stakeholders that – in Italy and abroad – interact with the company. The third edition of the Sustainability Report highlights an open and continuous exchange, where the company is the center of collective and shared actions: with internal interlocutors (staff), external (suppliers and clients), direct (business partners) or indirect (institutions, media, environment and communities).

Since 2015, with the project “L’Impresa dei Piccoli” (“the Business of the Little Ones”), OMAL has developed several paths of openness and dialogue with different actors, preferring small, local schools. At an aggregated level, the incidence on the company expenses for activities linked to the social value of business was 5,4% against the previous year EBIDTA, divided in 4,7% for social activities and 0,7% for environmental activities (as illustrated in the previous chapter).

In order to better understand OMAL path, the projects completed in 2018 are hereby listed, divided by impact areas.

4.1 THE INTANGIBLE REPUTATION OF OMAL BRAND

Among the different activities that a company needs to achieve, there is a high value-added sector connected to brand reputation. This sector includes all activities that increase – and improve – the company visibility, in areas that may return a virtuous image of it. OMAL has developed a path of corporate responsibility as a replicable system within MACRO processes (sales in Italy and abroad, production chain, external communication) and MICRO (internal communication, relations with suppliers), creating impacts on brand reputation and market positioning. These, defined intangible because not directly linked to an increase of quantities produced, can however be converted into money, as a result of the quantification of some variables, among which:

- *efficient management of the staff, that has an impact on human resources,*
- *innovation in business relations with suppliers and clients,*
- *Corporate Social Responsibility, intended as a driver to reduce risks and increase processing efficiency,*
- *managing quality for all relations, resulting from a clear communication between different units,*
- *the brand presence in public occasions, in contexts of study/research or policy creation, connected to the Brand participation in the debate on social and environmental issues.*



MEETINGS AND ACKNOWLEDGEMENTS

In November 2018, OMAL was invited to the annual meeting of Italian B Corp companies, after being recognized as a member in September 2017. The event took place in Bologna on November 28th and was entitled “#TimeToB”. The meeting welcomed businessmen and experts of new business models who wanted to receive updates and useful contacts to team up and create new opportunities for business collaboration. One of the most important aspect of being a B Corp is in fact the willingness to feel part of a movement of actors that, looking in the same direction, help each other and team up to protect a subject, sustainable business models, that is not avant-garde anymore but still finds opposition and skepticism.

During the event, the data on the B Corp movement in Italy were presented, a country that holds the record for number of certified companies in Europe, and the companies with the best assessment scores were also announced, in the single details of the analysis.

OMAL obtained the important world-level award “Best of the World 2018” for obtaining a score of more than 10% above the world average in the category “environmental impact” (out of 2700 certified companies).



This acknowledgement for best environmental performance according to the B Corp database has confirmed OMAL commitment to introduce sustainable production processes with a low environmental impact, deserving the status of “greenest” company in the category, at world level.

This acknowledgement, of extreme importance because given by one of the most advanced bodies in terms of Sustainable Business, is crucial to prove that also a business-to-business manufacturing company can effectively perform better than other companies that, often in the Business-to-Consumer field, are more used to confront their stakeholders about social and environmental impacts, and therefore closer to the values sponsored by B Corp.

In this perspective, OMAL represents an absolute novelty and an example to push other actors in the field to start sustainable and virtuous paths.

During the B Corp event, it was presented the letter to the G20 governments, written by profit companies and addressed to politicians to appeal to their sense of responsibility in terms of social and environmental sustainability.

In the letter, reference is made to the urgency of giving concrete answers to the ongoing climate changes and to the huge imbalances generated by classic economic models, that are causing global crises more and more difficult and expensive to manage.

The document, that includes the thoughts of about 2700 B Corp companies, has established some tangible steps to implement, primarily:

- forming a commission for the development of a positive impact economy;
- creating new legal forms of enterprises;
- envisaging a long-term leadership for the most urgent global issues.

28.11.2018 • B Corp Italian Summit • Bologna

LETTERA APERTA AI GOVERNI DELLE NAZIONI DEL G20



“Le aziende esortano i leader del G20 a guidare il cambiamento verso una economia a impatto globale”

Giovedì 15 Novembre 2018

Oggi, a più di dieci anni dal crollo finanziario globale, un gruppo di leader del mondo del business, imprenditori motivati e investitori d'impatto si uniscono per chiedere ai paesi del G20 di aiutare a costruire un sistema economico che sia al servizio delle persone e del pianeta.

**È NECESSARIA UNA
LEADERSHIP GLOBALE
CORAGGIOSA**

Siamo di fronte a un vuoto di leadership globale volto al bene comune. C'è un bisogno significativo di ridisegnare il nostro sistema economico e i suoi

Another extremely significant moment occurred during the B Corp event was the launch of the “Time to B Bold” project, aimed at identifying the best B Corp impact project for 2019. During the congress in Bologna the finalist initiatives of the contest were illustrated and B Corp companies were required to express their preferences to select the company to support in 2019, namely the winner of the contest “Best for Italy”.

Examining in details the projects presented in November, the most voted one was:

1 “Do we want the Mediterranean Sea plastic in our dishes?”

Presented by the B Corp Davines, it has the goal of spreading awareness on marine pollution caused by micro-plastics. According to UNEP, between 1987 and 1991, the plastic waste collected in Italian seas was only 3%, increased to 82% in 2015.



2 The second-placed project was: “B Corp School”

Invented by the B Corp InVento LAB, it is a work-related learning program to connect Italian B Corp companies with high school students. The concept of B Corp introduced in schools is considered an important factor of knowledge and education towards sustainable business, with a growing attention to social responsibility and the pursuit of sustainable development within profit companies.





The third project was: **“The Plastic Fisherman Club”**

Presented by WAMI, a B Corp company that produces bottled water, aimed at a periodic collection – among all B Corp companies - of the plastic bottles used. The projects envisages that all the plastic collected will be re-generated and reused for B Corp merchandising.



The results of the voting identified the first as winner, with 52,8% of the votes, followed by the second with 27,8% of the votes expressed by the B Corp community and, lastly, the third one voted by 19,4% of the voters.

OMAL participated to the voting and made itself available, as early as the end of 2018, to collaborate with other B Corp companies to promote virtuous models to reduce plastic waste.

CONTESTS

Aware of the importance of discussing with other companies that have voluntarily implemented projects connected to sustainability and responsible business, at the beginning of 2018 OMAL submitted its candidature for the “Cultura+Impresa” award, dedicated to cultural projects sponsored or, as in the case of OMAL, directly developed by Companies. The goal of the contest, awarding the best projects and giving value to both Cultural Operators and Companies that invest in Culture, is part of a progressive trend of accountability of profit actors towards the management of common goods as art and beauty. The economic actors awareness of their responsibility in the fields of cultural development and progress shows the importance of an award that can promote the best Italian experiences.

“It’s growing the number of Companies that – believing in the goodness and efficacy of Cultural investments, often focus of strategic plans and declined with non-occasional actions - decide not to sponsor an Institution, a Program, a cultural Operator, but to directly realize their own initiatives, associating themselves with the Culture”.

Curators of the “Cultura+Impresa” Award



The award won by OMAL, namely the special mention of Lombardy Region, has further confirmed the value of the commitment to make vibrant and significant all discussion opportunities within the company, not only the work-related ones.

To the “Corporate Art” project was recognized the merit of having opened a new communication channel in the company, as well as its innovative approach to work life, by exploring new ways to use different spaces with a high added-value.

OMAL has submitted to the jury its “Corporate Art” project, realized at the end of 2017 with the goal of engaging employees and their families in art and theatre workshops connected to the corporate vision on corporate social responsibility. The initiative is the result of a discussion between professional actors and street artists with the employees and their families, who, together, co-realized a theatre script on the subjects of team work, internationalization of the company, food balance and staff motivation. All accompanied by images and expressions as captured by theatre and painting, linking different opinions and perceptions within an industrial sector - the mechanical engineering one - and an art style - the street art - that had never started a dialogue before, thanks to the narrative help of the theatre.

MENZIONI SPECIALI

REGIONE LOMBARDIA

con **Alessandro Rubini** - Project Leder IC Innovazione Culturale - **Fondazione Cariplo IX. OMAL SpA - Corporate Art**
Lucia Dal Negro - Innovation Manager

DIGITAL INNOVATION IN ARTS

con **Anna Puccio** - Direttore Generale - **Fondazione Italiana Accenture X. Fondazione FS Italiane - Digitalizzazione del Patrimonio Storico del Gruppo FS**
Ernesto Petrucci - Responsabile del Servizio Biblioteca e Archivi **Fondazione FS Italiane**

SPONSORSHIPS

In September 2018, OMAL actively participated to the success of KISS Misano “Keep it Shiny and Sustainable”, the program of environmental and social sustainability connected to the Moto GP that takes place every year during the San Marino and Rimini Riviera Grand Prix, engaging teams, pilots, public, fans, companies, workers, local communities and non-profit organizations.

The program, developed and coordinated by the Right Hub company and sponsored by the Misano World Circuit, FMI (Italian Motorcycling Federation), FIM (International Motorcycling Federation), Dorna and Irta (International Road Racing Teams Association), has the goal to increase collective awareness on the importance of behaving in a sustainable way also during big sport events, not only in our daily life.

Among many initiatives, there has been spreading awareness within the Misano Circuit on the subject of waste management: from recycling to collecting surplus food. OMAL engagement in this event, now in its second edition, has not been merely economic, since OMAL is a sponsor of the program, but also it has been decided to help the organizers of the two-day sport event with eight volunteers who participated in the KISS Misano program for the weekend.

In practice, OMAL team followed the works of the Kiss info-desk in the paddock, helping the Right Hub Team in the collection of surplus food and exhausted cooking oil, explaining then to the guests how to recycle correctly and where. It is further noted that the campaign “Set in motion the recycle” started, with an in-depth analysis on respecting the oceans and the prevention of plastic pollution. Lastly, OMAL staff managed a desk to provide information materials to raise the awareness of the public, especially families and children, who were engaged thanks to special gadgets dedicated to environmental sustainability.

Also for the 2018 edition, it is important to mention the most relevant social and environmental impacts, in which OMAL participated as a protagonist in raising awareness on food waste towards all the event stakeholders, collecting surplus food in partnership with the Banco Alimentare Emilia Romagna (“Emilia Romagna Food Bank”) and Cuki in the paddock, Circuit and team hospitality areas, the Dorna Vip Village and in the spectator area at the Ducati Stand.

The “KISS Misano Crew” (composed of Right Hub staff, volunteers of the associations Sport and Sustainability Italy and Impulse Modena Racing of the University of Modena and Reggio Emilia, and volunteers of the Supporter Company OMAL S.p.A.) achieved the 45,6% of sorted waste collection inside the facilities of the San Marino and Rimini Riviera Grand Prix.

As far as concerns the surplus food collection, it was carried out on Saturday 8 and Sunday 9 September, in partnership with Banco Alimentare (Food Bank). The aluminum containers used for the collection have been provided by Cuki Cofresco and distributed to everyone joining the initiative. The project, that have involved many hospitalities (Team, Dorna VIP Village, FIM, Clinica Mobile, Summertrade Hospitality Riviera, Ducati Stand) was made possible thanks to the participation of Banco Alimentare Emilia Romagna volunteers and Kiss Misano staff, who on Saturday 8 September collected and recovered 646 meals, while on Sunday 9 September 1.236 meals and 300 kg of different food, including 200 kg of fruit and vegetables, equivalent to 600 meals (one meal corresponds to 500 grams of food as estimated by the European Food Banks Federation).

Overall, 2.482 meals were recovered in two days. The surplus food collected, delivered the same evenings of Saturday and Sunday, was donated to 5 charity facilities, managed by the Comunità Papa Giovanni XXIII Association in Rimini, a non-profit organization founded by Father Oreste Benzi more than 30 years ago. The 5 facilities (4 in Rimini, 1 in Savignano sul Rubicone) help people and families

in need (795 people in total) by distributing food. Among these facilities, there is the “Capanna di Betlemme”, that also provides night-care assistance to homeless people.

KISS Misano

Keep it Shiny & Sustainable



4. COMMUNITY AND BUSINESS MODEL

From the staff perspective, the experience was greatly appreciated and its social-environmental value was recognized and fully supported.

“For us it was a great adventure and the Kiss Misano organization was excellent: it’s not easy to get the attention on the subject of recycling with fans in a racetrack. The gadgets and toys available were useful to encourage people to listen to suggestions on how to recycle correctly”.

“What impressed me the most was the number of meals that the different Hospitalities have recovered and donated to charities to help those in need. We should definitely repeat this experience, it was an opportunity to learn new things and meet many people. We recommend it to everybody”.

“We were near the VR46 Turn, a transition area for public and fans, especially between races. We met many people and it was nice to exchange some words on such an important subject as environmental sustainability, in a place and for an occasion that apparently have nothing to do with this subject”.

“We engaged people passing by with games and we gave them some gadgets that were really appreciated because made with recovered materials. The event was a great success and I’ll suggest to other friends and colleagues to participate in the next editions”.



4.2 VIRTUOUS BUSINESS MODEL

TO BE B CORP

Omial produce da 40 anni valvole e attuatori con progettazione, sviluppo e lavorazione interamente italiani.

È diventata B Corp perché vuole essere un riferimento sicuro e affidabile per suoi partner nel rispetto dei più elevati standard di responsabilità e trasparenza



For OMAL, living and representing a responsible profit model means do our best for all our clients and stakeholders. The company however acknowledges the importance of communicating with other responsive and well-advanced profit actors. For this reason, in February 2018, OMAL required to become a Founding member of Global Compact Network Italy, the foundation that locally organizes training, information, awareness and networking events for companies that can be interesting for, or interested to, International Global Compact Principles, in order to create an increasingly favorable eco-system for these values in Italy.

Moreover, the B Corp certification, obtained by OMAL in September 2017, is linked to the Benefit Corporation movement, that represents an evolution of the concept of company: in fact, while traditional companies

have the only goal of distributing dividends to shareholders, B Corp companies are the result of a more advanced paradigm, integrating in their business purposes, in addition to profit goals, the importance of having a positive impact on the society and biosphere. This virtuous goal has always been part of OMAL identity, as reflected in the company's mission and vision, that are reported below.



We guarantee a better world for our children. Thanks to our products, we safeguard the environment around us and we tangibly improve the quality of life, making our plants safer and more reliable.

A fair balance between man and environment improves the quality of life and guarantees a better future for next generations.

4. COMMUNITY AND BUSINESS MODEL

Benefit companies are not Social Enterprises, nor an evolution of non-profit sector, but a positive transformation of the dominant models for profit companies, in order to make them more suitable for the challenges and opportunities of the XXI century markets. As opposed to non-profit organizations, such as ONLUS, APS, Social Enterprises etc., benefit companies keep their profit-oriented goals, without any special limitation, and add to this a further objective, that is to pursue one or more social goals. Moreover, as opposed to non-profit organizations, B Corp do not use fundraisings or external donations to achieve their social corporate goals, because they are already included in their business activities.

From a legal point of view, in January 2016 Italy, first in Europe and in the world after the USA (where the legal form of Benefit Corporation, equivalent to the Italian Benefit Company, was introduced in 2010 and now exists in 33 States) introduced the legal form of Benefit Company to allow businessmen, managers, shareholders and investors to protect their corporate mission and distinguish themselves from all other forms of company existing in the market through a virtuous and innovative legal entity. The legislation governing benefit companies is included in the law n. 208 of the 28/12/2015 (2016 Stability Law), Art. 1, Paragraphs 376-384, that came into force on January 1st, 2016. At the moment, benefit companies do not receive fiscal or economic incentives, so, beside representing a value for the society, they do not burden taxpayers.

OMAL interest in completing the certification path to become a B Corp started in March 2016, and after a year and a half of commitment to develop and measure social-impact activities, at the end of September 2017 OMAL obtained a score of 107/120, and could therefore start the review process. The B Corp internal supervisor has carried out three review calls, during which about thirty randomly chosen questions were asked, and for each of them it was necessary to send further support data. After two months of work, between July and September 2017, the score was confirmed, particularly high for a company that handles metals and not a service provider.

This certification can represent the first step to imagine to become a benefit company. So far, OMAL has been able to become one of the most responsible company in the world, proving to have internalized ethical and environmental values to the point of making them an integral part of its activities, a characteristic of "OMAL way" of doing business.

To exemplify what OMAL means with "being a responsible profit company", two cases may help to better understand this concept.

The first case refers to the Conflict-Minerals Declaration, that OMAL draws up for its US clients, if they require it. The document reports the use of minerals (in particular Tin, Tungsten, Tantalum and Gold) from countries affected by armed conflicts or widespread human rights violations, as the Democratic Republic of the Congo and its neighboring States (Rwanda, Burundi, Angola, Central African Republic, Sudan, Tanzania, Uganda and Zambia). OMAL is committed to respect these provisions and therefore collects information from its supply chain about the presence and use of these minerals. It should be pointed out that the regulation does not forbid the use of non conflict-free minerals, namely from conflict zones, but it imposes on American companies, that operate in the USA or export to the USA, the obligation of informing the final consumer on the origin of minerals, so that he or she can choose which products to buy. It is also interesting to note that the European Union followed this American procedure and published, in May 2017, the Regulation 2017/821, that imposes on all European importers, with the exception of the smallest, of minerals and metals containing tin, tungsten, tantalum and gold to carry out checks to ensure that their suppliers respect due diligence requirements. Recycled materials and small importers, representing 5% of imports, are exempted in order not to impose an excessive bureaucratic burden.

The Regulation demands to importers to mandatorily carry out checks starting from January 1st 2021, to allow member States to establish competent authorities and give importers time to become familiar with their new obligations.

The second tangible example of how OMAL intends being a profit-company, following a model able to generate positive social impacts, is represented by the full compliance with the EC Regulation n. 428/09, that established a community system for checking exports, transfers, brokerage and transit of Dual Use products. Goods and technologies are considered Dual Use when they can be used for civilian applications but also for military productions, developments and uses. As opposed to armament materials, these items are not explicitly designed for military use but that is what they could turn into. The creation of a common systems to check exports (EC regulation 428/2009), applicable in every Member States, is a necessary condition to ensure compliance with the commitments and responsibilities of the States on non-proliferation and a key prerequisite for the free movement of dual use products. OMAL guarantees compliance with the provisions of EC Regulation n. 428/09 and Italian Legislative Decree 221/2017, verifying that materials and products intended to be exported outside the European Union are not listed among dual use goods; requesting, if necessary, the relative authorizations to the MISE (Ministry of Economic Development); and operating in compliance with EU provisions on trade embargoes. To this end, OMAL has established a specific “Export compliance” procedure.

WORK-RELATED LEARNING

Work-related learning is an innovative didactic model that, through practical experience, helps to consolidate the knowledge acquired in school and field-test the students skills, enriching their education and orientating their studies and future work, thanks to programs linked to their study curriculum.

Work-related learning, mandatory for all students in their last three years of high schools, including lyceums (upper-level secondary schools), was introduced by the Law n. 107 of 2015 (“Good School” reform), in line with the principle of open school.

OMAL believes that the value of these vocational activities is the importance of training students in the best way, in constant dialogue with schools and families, sharing processes and practical and training activities. This helps both the company to better understand the needs of new generations, that one day could work in OMAL, and the students to have an insight of office work-life.



In details, Work-related learning programs establish that boys and girls are welcomed in adequate and safe training environments, that can help them grow as people and are coherent with their study curriculum.

At the end of the program, students will have the right to express their assessment on the efficacy and coherence of their experience with their curriculum, and they have to be supported by a tutor of the hosting company in relation to the risks of the implemented activities.

In OMAL, following the 2017 experience (22 May – 30 June) in the Communication and Quality Department, the Work-related learning program was carried out from 21 May to 15 June 2018, welcoming a girl in the Administration department.

In February 2019 a new Work-related learning program started in the Quality Control department.



COMMUNITY VOLUNTEERING

The project originates from the desire of the Ownership to engage the employees in activities with a social added value, so that OMAL workers can put their time, motivation and skills at the service of the community. A similar approach, particularly innovative if we consider that in Italy very few companies have implemented structural activities of corporate volunteering, surpasses the model of traditional philanthropy as a tool to help local realities in need, and allows to raise social awareness, that is put into practice with hours of volunteering activities to answer to local needs.

So, starting from this awareness, the creation process of the project underwent a first step of participatory planning between OMAL General Management and all employees, that took place in 2015 during the EMPOWERED DAY, an event that OMAL has organized since 2012 to meet the staff and share with the entire organization goals, corporate strategies and results obtained.

After this step, the stakeholders mapping was prepared, that allowed OMAL to understand which organizations were locally active and potentially interested to host OMAL volunteers for carrying out their activities.

During the following three years, the activities where volunteers were able to help local associations were often suggested to the company by the territory, in a spontaneous way, demonstrating a high receptivity of local communities and a strong will to build a dialogue between profit and non-profit.

4. COMMUNITY AND BUSINESS MODEL

Below is a list of the organizations that have been partners of the Community Volunteering project:



RUT Organization > activities of companionship and entertainment with nursery teachers; maintenance of green areas; companionship for the elderly;

“Ai Caduti” Comprehensive Institute, Rodengo Saiano > IT support activities, archives reorganization activities; warehouse management;

“Tilde e Luigi Colosio”/GENESI Nursing Home > activities of companionship and entertainment together with the doctors, assistants and animators of the facility;

Manitese NGO > fundraising activities for Christmas in partnership with Feltrinelli;

“Madre Teresa” Healthcare Facility > activities of companionship and entertainment together with the doctors, assistants and animators of the facility;

“La Vittoria” Preschool, Provaglio d’Iseo > activities to reorganize gardens and play areas;

Icaro Basket > fundraising, support and accompanying activities;

Casa Bau > care and assistance activities for the dogs of the shelter, especially cleaning spaces, recreational activities and animal care;

Cavalli per Tutti, Horses for Everybody > support to pet therapy activities, especially horseback riding for disabled people and equestrian rehabilitation;

Villa Carcina Civil Protection > maintenance activities for mountain huts and trails.

Community Volunteering activities were annually scheduled so that OMAL employees could submit their participation up to a maximum of 16 hours a year, to be spent during working hours.

Focusing on the impacts of OMAL Community Volunteering project for the three-year period 2016-2018, the metrics have underlined the following outcomes:

- total number of participants in the initiative (2016-2018 data) > 133 employees
- total number of hours dedicated to the community (2016-2018 data) > about 1.200 hours in the three-year period
- % of employees who have participated (2016-2018 data) > an average of 50% in the three-year period

Despite the success of the “Community Volunteering” initiative, with an average employee participation of 50% in the three-year period, the hours dedicated to the project have progressively decreased. In a condition, as in the past years, of strong development and internal reorganization, it has been difficult to keep a high staff participation and there have been some difficulties in managing the hours scheduled to be spent during working hours. Moreover, new projects and activities in other fields have been a reason for distraction.

Very positive is the opinion of organizations and associations that have been helped by OMAL volunteers, in fact, after analyzing the satisfaction surveys sent in 2018 to verify problems or possible improvements, a general level of satisfaction was revealed.

In each case, the help of our volunteers has been deemed fundamental to improve local services and all organizations and associations have made themselves available to redefine the volunteers' engagement parameters with OMAL, also with new modalities, for future participations.

DAY AT AMALDI HIGH SCHOOL IN BERGAMO

In 2018 the company invested much in dissemination, i.e. sharing with its stakeholders the value of the activities planned during the year. The performance of social-economic activities, in fact, has to be accompanied by the physiological needs of the company that, in a continuous evolution, in 2018 has aimed at strengthening what had been done before more than opening new opportunities, hard to carry out during regular working hours. Within this strategy, OMAL staff – represented by the spokesperson of the Environmental Management System – has participated to an orientation day at the **AMALDI High School in Alzano Lombardo**, on the topic of Green Jobs.



The goals of this day, organized by engaging principals and school staff, were several: primarily, informing students on current social and economic changes, to make them responsible on different subjects – including the environment – that will be worth considering in any job they will choose, and, even before, in their decision if continuing - or not – their studies. The second goal was to be an inspiration, make the public curious on social-environmental issues as presented and personified by OMAL spokesperson, who also answered questions and addressed doubts. In particular, the contents and purposes of the ISO 14001:2015 standard, explained in its most interesting aspects for that audience, have stimulated many questions on the meaning of a serious corporate environmental commitment, far from green-washing. Lastly, the opportunity to listen to the experiences of those who have responsibility roles within companies, also on environmental issues, has allowed an in-depth analysis on the more personal aspects of this profession, linking them with the decision to continue the studies.

More specifically, OMAL spokesperson contribution underlined the importance of always believing in our job, even in case of failures, that must be faced with a long-term vision and desire to improve. In details, it has been presented a future scenario – referred to OMAL sector – where, in all likelihood, the use of automation will increase, integrating units in a more complex way, and where new skills (foreign languages, IT, specialized) will be needed. Within this scenario, every single contribution becomes important because, even if a company is an organization, the worker can participate in a coordinate way, expressing his/her ideas and knowledge: the balance between personal fulfillment and alignment with the work team is one of the most delicate aspect when analyzing a worker maturity. Lastly, not avoiding the question, OMAL spokesperson expressed his vision in terms of Green Economy, stressing the importance of not transforming it in green marketing, a mix of short-term activities, shortcuts and slogans not related to a real 360 degrees commitment to the environment, about which he also highlighted the role of companies in its protection.



VISIT OF THE PUPILS OF PASSIRANO MIDDLE SCHOOL

Lastly, always during 2018, OMAL has welcomed the eighth grade students of the **Comprehensive Institute of Passirano (BS)**, a school located only a few kilometers away from OMAL production plant. The visit was sponsored by the Municipality of Passirano to help students in the choice of the right kind of high school, so that they could see with their own eyes a work environment with different kinds of professionals and skills: administrative, management, sale, IT. In this event too, OMAL wanted to give back to its community and future generations an idea of responsible and sustainable business, open and in a constant dialogue with its stakeholders.

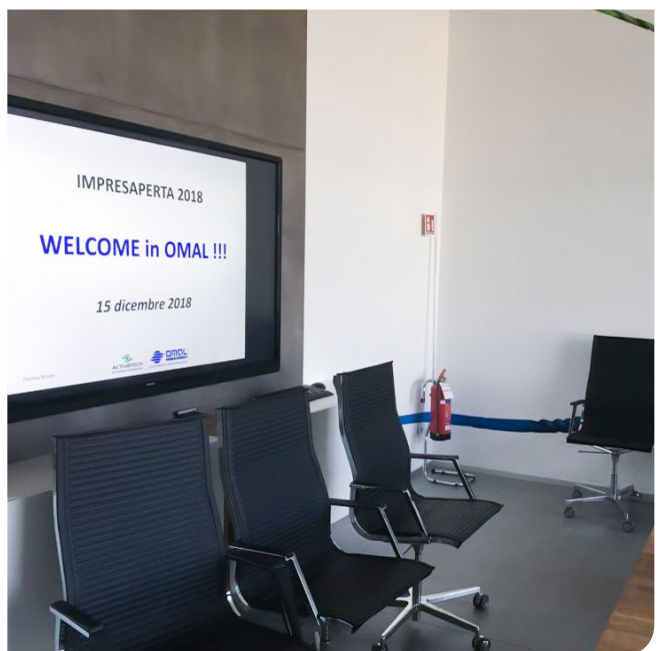





PROSPECTS AND
CONCLUSIONS

5

THE COMPANY, THE COMMUNITY AND THE FUTURE

The dialectic between company, community and territory is one the most exciting frontier of Brand Reputation, also in a B-to-B context. Every company, in fact, interacts with its surrounding territory, becoming a creative actor with a social added-value. This does not only refers to the employment generated, but also to that network of values that companies – by virtuously behaving with all internal and external stakeholders – demonstrate in their everyday working life.

OMAL, encouraged by the positive results and feedbacks achieved so far, also for 2019 intends to renew its commitment to represent a positive value model, an example for the territory of Brescia and the whole sector.

In the future, the company intends to create a network and team-up with those local companies that want to join OMAL commitment and support shared projects that could be managed, even in rotation, by the partners involved. This could help the progress of projects, maximizing the energies available and potentially opening new paths. The idea of increasing collaborations with other equally responsible profit partners is also strictly linked to the B Corp mandate, that, as illustrated above, counts on a shared planning between different companies. 2019 is expected to be, for OMAL, the year of networking and sharing.



THE COMPANY, THE ENVIRONMENT AND THE FUTURE

The relation of OMAL towards the environment has always been marked by utmost respect, based on a constant improvement process of internal mechanisms of procurement and production, so that the company's environmental impacts are monitored and they are lower than the sector average. A proof of this is the B Corp award that the company won for its environmental commitment, as well as the ECOVADIS Gold rating, the renewal of environmental certifications and internal policies and the growing efficiency of energy consumption in both our plants.

OMAL believes it must continue these paths of environmental sustainability and make them structural, an intrinsic part of corporate activities at all levels, increasingly engaging its employees and suppliers. The goal for the coming years will be to pay more attention to the sustainability of OMAL products, with a design of valves and actuators that can ensure a longer average life, reduced energy consumption and an easier disassembly for a better disposal and recovery of materials.

In this path, it becomes strategic to consider "enlarged management models", that can reduce overall impacts by engaging all the actors of the chain, creating a sustainable value for stakeholders and minimizing inefficiencies and risks. This means adopting strategic management measures towards a Green Supply Chain, in order to reduce environmental and economic risks, improve the operative efficiency of the system and the Green innovation of processes and products.

In the future, the company intends to replicate responsible innovation, that has been tested at environmental level, extending it to all corporate levels and bringing in the internal processes new goals, logics, techniques and procedures oriented towards environment protection and sustainability, sharing them with its staff and supply chain, true to the motto "Walk the Talk", namely to keep the promises made.

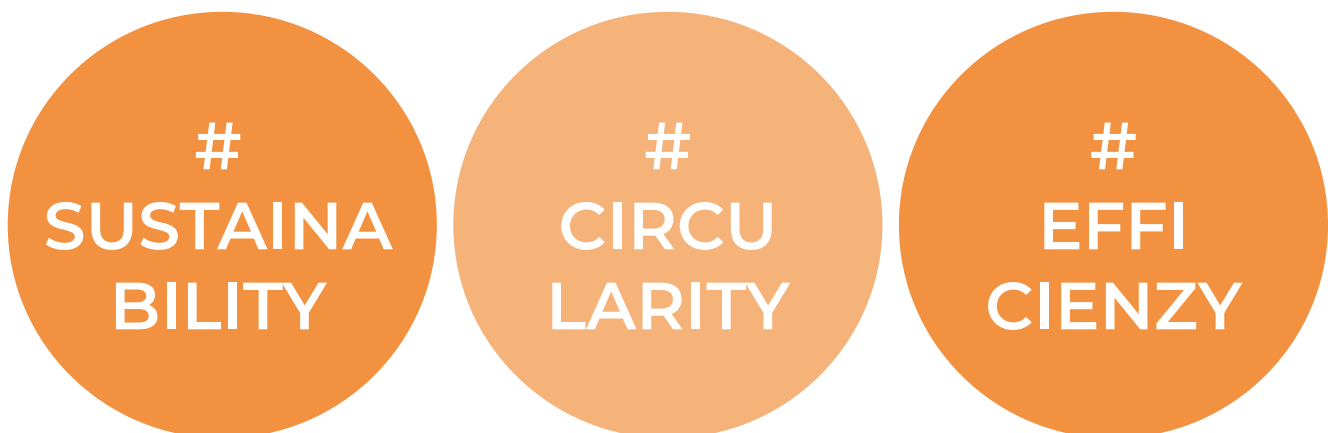



THE COMPANY, THE QUALITY AND THE FUTURE

The concept of corporate quality is very broad, originally born to characterize a product or service and only later associated to the production process, the quality of life in the company, the brand image and the relations with stakeholders. From this progressive evolution of the notion of quality, we can notice an extension of its conceptual borders and – therefore – operational, becoming the strategic compass that orients the kind of product placed on the market, the corporate strategy for preventing and managing risks, the staff engagement and the profile of the suppliers.

OMAL has been one of the first companies to align with the renewal of ISO 9001:2015 standard, proving that it is not interested in chasing betterment but being a part of it, immediately adjusting its improvement processes. The same principle is valid for product certifications, that indicate a constant updating with the presentation of new certificates at the same time new products are released. This is precisely why the quality path, in OMAL, is an open and ongoing process, as happens for all realities most receptive to change.

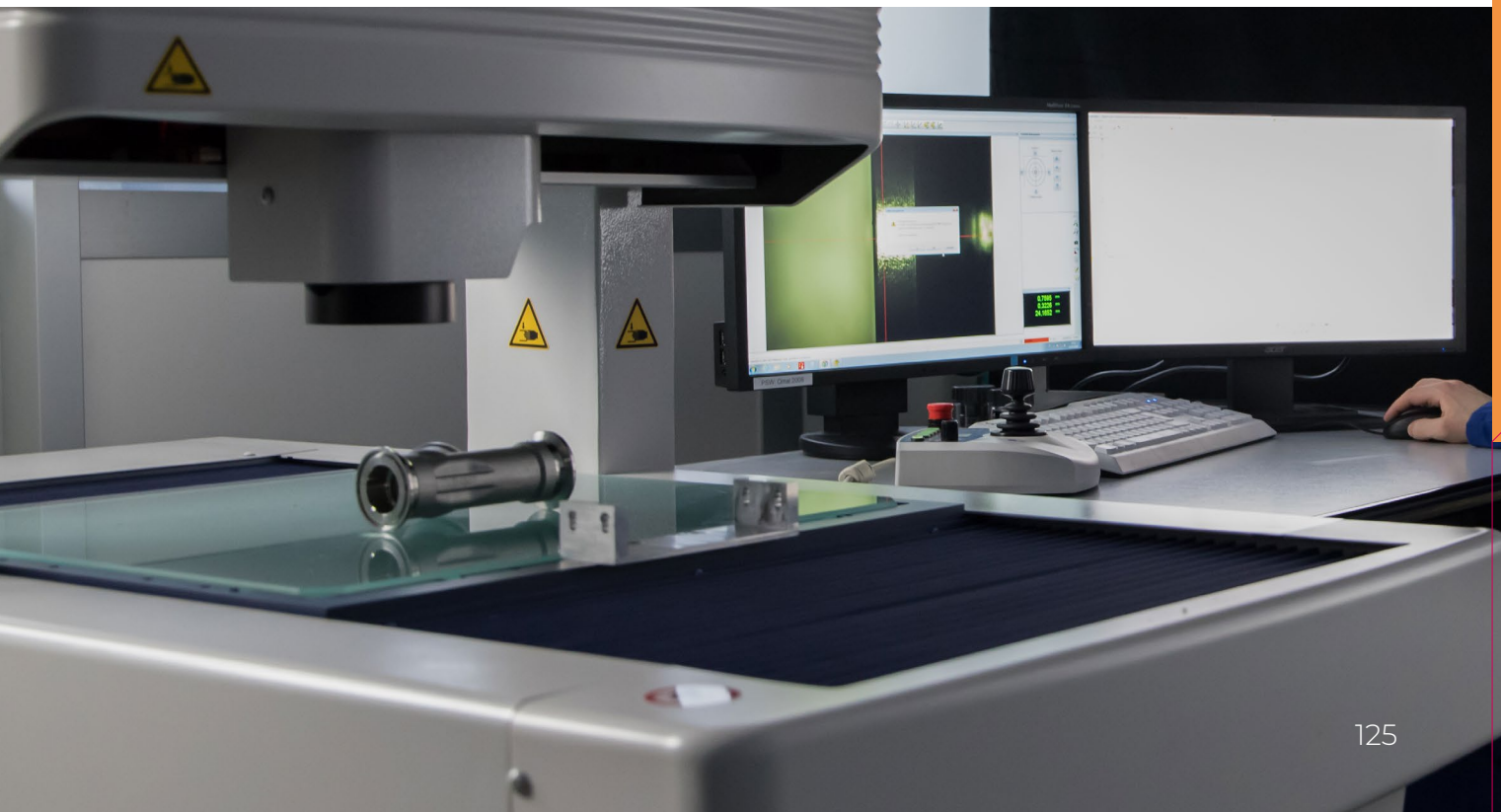

CONCLUSIONS

For OMAL, 2018 was the third year of reporting corporate sustainability: it was a complex period, during which we took huge steps towards updating production technologies and bringing the company to adopt a model of virtuous mechanical digitalization, meaning that it happened without the staff paying its cost. The choice of investing in advanced technologies is the proof of the concrete commitment towards our organization (especially our staff) and OMAL desire not to give up the excellence pact made with its clients.

The activities of corporate responsibility were partially affected by the enormous efforts the company made to keep up with the Industry 4.0 principles in both its plants. For this reason, 2018 was the year of continuing the processes already undertaken and strengthening the results obtained more than the year of corporate growth and innovation.

This is the expression of a physiological change of needs: the company is, in fact, a complex organism that has different stages of development. OMAL, however, does not intend to give up on the extraordinary results so far obtained: the goal remains to be “empowered” and this requires commitment and perseverance.

The company does not want to waste the huge added-value created in the past years, learning how to regulate its energies and how to engage all stakeholders around the most virtuous and strongest initiatives, that can strengthen the sense of belonging to the organization and the ability to build a dialogue with local communities, continuing the ongoing activities and/or launching new ones.

The commitment to the environment, instead, was consolidated, updating and renewing internal policies for an increasingly careful and rational management of resources, to reduce environmental impacts. This attention is more and more widespread within the company, it involves every unit and permeates daily operations.

On these pillars is grafted the B Corp promise for a responsible and growing business, that looks the future in the eyes: a promise that the company intends to fulfill.





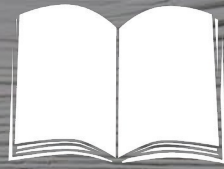

ANNEXES

RENEWED PARTICIPATION TO GLOBAL COMPACT



Omal S.p.A.

Headquarters: Via Ponte Nuovo 11, 25050 Rodengo Saiano Brescia Italy
Production Site: Via Brognolo 12, 25050 Passirano Brescia Italy
Ph: +39 0308900145 Fax: +39 0308900423 VAT nr. 00645720988
Web Site: www.omal.it E-mail: info@omal.it

H.E. Antonio Guterrez

Secretary-General

United Nations

New York, NY 10017 USA

Dear Mr. Secretary-General,

I am pleased to confirm that Omal S.p.A keeps on supporting the ten principles of the Global Compact on human rights, labour, environment and anti-corruption for this second year of commitment. With this communication, we express our intent to implement those principles and advance in improving the corporate engagement on such key values. We are committed to making the Global Compact and its principles part of the strategy, culture and day-to-day operations of our company, and to engaging in collaborative projects which advance the broader development goals of the United Nations, particularly the Sustainable Development Goals. Omal S.p.A will reaffirm its clear statement of this commitment to our stakeholders and the general public.

We recognize that a key requirement for participation in the Global Compact is the annual submission of a Communication on Progress (COP), which we will upload by the due date for the second year of our participation to the Global Compact. As we support public accountability and transparency, we reaffirm our willingness to report on progress annually, according to the Global Compact COP policy.

Sincerely yours,

Amdeo Bonomi, CEO

A handwritten signature in blue ink, appearing to read 'A. Bonomi', is placed below the typed name.



ACCEPTANCE LETTER



Global Compact Network Italia



Rome, March 12th, 2018

Dear Mr. Bonomi,
with regard to the application for membership at the Global Compact Network Italia as Founder, submitted by OMAL on February 20th, 2018, I hereby inform you that your request has been examined and accepted by the Board of Directors of the Foundation, at its meeting on March 8th, 2018. Therefore, it is my pleasure to inform you that, as from that date, OMAL SpA has formally acquired the status of Founder of the Global Compact Network Italia.

As Founder of the GCNI, OMAL SpA, as provided for in the Articles of Association, has the right to participate to the association activities and meetings, with the right to vote, and access to the information material prepared by the Foundation. OMAL SpA also agrees to contribute to the achievement of the Foundation goals, not only with an economic support but with an active participation to the institutional life and the implementation of the planned initiatives.

In welcoming you in the Global Compact Network Italia Foundation and hoping to meet you soon, I am available for any further information and/or clarification.

Best Regards.

Chairman -
Global Compact Network Italia Foundation

FONDAZIONE GLOBAL COMPACT NETWORK ITALIA

Via Cereate, 6 - 00183 Roma
info@globalcompactnetwork.org
www.globalcompactnetwork.org



ENVIRONMENTAL POLICY



Omal S.p.A.

Headquarters: Via Ponte Nuovo 11, 25050 Rodengo Saiano Brescia Italy
Production Site: Via Brognolo 12, 25050 Passirano Brescia Italy
Ph: +39 0308900145 **Fax:** +39 0308900423 **VAT nr.** 00645720988
Web Site: www.omal.it **E-mail:** info@omal.it

ENVIRONMENTAL POLICY

OMAL takes up the challenge of growing and establishing itself on the market through the development of a sustainable business to *"meets the needs of the present without compromising the ability of future generations to meet their own needs."*

The environment protection and the sustainability are essential parts of our trade policies and strategies. We manage the processes in order to guarantee the environment respect and protection, the optimal use of natural resources and raw materials.

We involve the stakeholders to provide products, solutions and services that meet their current and future needs and exceed the same market expectations.

Understanding the needs and expectations of the stakeholders we strengthen our competitiveness, the ability to maintain and promote new investments, the vitality and continuous development of our organization.

We implemented, apply and maintain an Environmental Management System in accordance with the UNI EN ISO 14001 standard, in order to pursue the continuous improvement of our environmental performance through:

- The compliance with the laws and the rules in force on environment protection and other applicable requirements, included in the contractual relationship with our customers.
- Identification of environmental aspects and management of the related impacts on which we can exercise control;
- The risks analysis and opportunities for improvement evaluation that could affect the effectiveness of Environmental Management System and the satisfaction of the needs of the stakeholders.
- Research and development of solutions that guarantee quality, reliable products with a long service life, carried out in compliance with the principles of sustainability.



Omal S.p.A.

Headquarters: Via Ponte Nuovo 11, 25050 Rodengo Saiano Brescia Italy
Production Site: Via Brognolo 12, 25050 Passirano Brescia Italy
Ph: +39 0308900145 **Fax:** +39 0308900423 **VAT nr.** 00645720988
Web Site: www.omal.it **E-mail:** info@omal.it

With reference to the above-mentioned points, we set the following goals:

- Reduce the consumption of resources (materials, fuels, energy and water resources) through technological innovation or the adoption of better performing technical and organizational solutions both from the point of view of productivity and energy efficiency.
- Prevent possible risks of local pollution by the continuous monitoring of our production sites environmental impacts and along the supply chain.
- Minimize waste production by promoting recovery and / or recycling of materials according to the circular economy principles.
- Define the characteristics and performance of products that ensure the environmental impacts control during the service and at the end-of-life cycle.
- Improve communication within and outside the organization: involve the stakeholders at all levels in order to promote the diffusion of a sustainability-oriented work culture.

We believe that the balance between human and environment improves the quality of life, ensuring a better world for future generations.

The Mission that we respect every day makes us credible and reliable actors because with the valves & actuators we manufacture we take care of the environment and we improve the quality of the life making safer and more reliable plants.

Rodengo Saiano, 05 November 2018

Amedeo Bonomi
CEO

A handwritten signature in blue ink, appearing to read "A. Bonomi", is placed below the printed name and title.

SUSTAINABLE PROCUREMENT POLICY



OMAL S.p.A.

Headquarters: Via Ponte Nuovo 11, 25050 Rodengo Saiano Brescia Italy
Production Site: Via Brognolo 12, 25050 Passirano Brescia Italy
Ph: +39 0308900145 Fax: +39 0308900423 VAT nr. 00645720988
Web Site: www.omal.it E-mail: info@omal.it

SUSTAINABILITY PROCUREMENT POLICY POLITICA DEGLI ACQUISTI SOSTENIBILI

OMAL SPA si impegna a individuare e gestire gli impatti ambientali e sociali connessi alla produzione e vendita di valvole industriali ed attuatori, inclusi quelli derivanti dall'approvvigionamento di prodotti e servizi, mediante il coinvolgendo della propria catena di fornitura.

Riconosciamo che si tratta di processo di lungo periodo e che i nostri fornitori sono partner importanti verso la costruzione di pratiche responsabili, e quindi sostenibili.

A tale scopo intendiamo:

1. attuare le nostre politiche e pratiche di approvvigionamento in accordo con i nostri valori, i principi del nostro codice Etico ed in particolare del Codice di Condotta fornitori adottati in accordo con i 10 principi del UNITED NATIONS GLOBAL COMPACT:

- I: Promuovere e rispettare i diritti umani universalmente riconosciuti nell'ambito delle rispettive sfere di influenza.
- II: Assicurarsi di non essere, seppure indirettamente, complici negli abusi dei diritti umani.
- III: Sostenere la libertà di associazione dei lavoratori e riconoscere il diritto alla contrattazione collettiva.
- IV: Sostenere l'eliminazione di tutte le forme di lavoro forzato e obbligatorio.
- V: Sostenere l'abolizione del lavoro minorile.
- VI: Sostenere l'eliminazione di ogni forma di discriminazione in materia di impiego e professione.
- VII: Sostenere un approccio preventivo nei confronti delle sfide ambientali.
- VIII: Intraprendere iniziative che promuovano una maggiore responsabilità ambientale.
- IX: Incoraggiare lo sviluppo e la diffusione di tecnologie che rispettino l'ambiente.
- X: Lottare contro la corruzione in ogni sua forma, incluse l'estorsione e la concussione.

2. Selezionare partner commerciali ed organizzazioni che:

- *condividano i nostri valori e la nostra sensibilità in materia di sostenibilità ambientale e sociale (sottoscrivano il nostro CCF);*
- *adempiamo agli obblighi in materia di protezione dell'ambiente e di CSR (sottoscrivano i requisiti legali della fornitura);*
- *adottino iniziative volte alla prevenzione dell'inquinamento e/o alla conservazione dell'ambiente.*
- *Abbiano implementato un sistema di gestione ambientale o abbiano intenzione di farlo.*





EMPOWERED PERFORMANCE

OMAL S.p.A.

Headquarters: Via Ponte Nuovo 11, 25050 Rodengo Saiano Brescia Italy
Production Site: Via Brognolo 12, 25050 Passirano Brescia Italy
Ph: +39 0308900145 **Fax:** +39 0308900423 **VAT nr.** 00645720988
Web Site: www.omal.it **E-mail:** info@omal.it

3. Supportare i fornitori nell'adozione delle pratiche più virtuose, così da ridurre al minimo gli impatti ambientali e sociali lungo la catena di fornitura.
4. Monitorare sostenibilità della catena di fornitura in particolare nei processi critici di approvvigionamento.
5. Integrare nei documenti contrattuali requisiti vincolati ai principi della sostenibilità e condividerli con la catena di fornitura.

I nostri obiettivi sono:

1. **RIDUZIONE DEGLI SPRECHI**
(mediante riduzione dei consumi o riutilizzo, riciclo, recupero materia prime/imballi...)
2. **OTTIMIZZAZIONE DEI PROCESSI DI APPROVVIGIONAMENTO**
(es. Progetto GREEN IN, misurazione e compensazione delle emissioni di CO2 da logistica in ingresso)
3. **PROMOZIONE DI COMPORTAMENTI VIRTUOSI INTERNI ED ESTERNI ALL'ORGANIZZAZIONE**
4. **MONITORAGGIO DELLE PRESTAZIONI AMBIENTALI DEI FORNITORI**
5. **CONDIVISIONE DELLA NOSTRA POLICY CON LA CATENA DI FORNITURA**





Rodengo Saiano, 15 Novembre 2018

Thomas Buizza
Procurement Manager









INTERNAL TARGETS AND PERFORMANCE

COMMUNITY

| | |
|---|---|
| <p>1 Sharing of OMAL Supplier Code of Conduct with suppliers.</p> |  |
| <p>2 Maintenance and/or improvement of our ethical-social ratings.</p> |  |
| <p>3 Maintenance and/or improvement of our philanthropic commitment.</p> |  |
| <p>4 Hours dedicated by the staff to volunteering activities, compared to 2017.</p> |  |
| <p>5 Sharing of business strategy, targets and results with our employees.</p> |  |

ENVIRONMENT

| | |
|---|---|
| <p>6 Maintenance and/or improvement of our environmental ratings.</p> |  |
| <p>7 Energy supply 100% from renewable sources.</p> |  |
| <p>8 Recovery and recycle of 100% of cardboard and paper packaging.</p> |  |
| <p>9 Extending the sorted waste collection system to the company canteen.</p> |  |
| <p>10 Keeping the % of hazardous waste, on total waste, under 5%.</p> |  |

11 Creating chain relations with suppliers, to ensure the management of aluminum and brass waste according to “circularity” principles. 

QUALITY

12 Updating internal policies. 

13 Maintenance of management systems and product certifications. 

14 Achievement of the internal digitalization and computerization goals with the Smart Factory project. 

15 Achievement of the process automation goals (e.g. Industry 4.0). 

16 Updating our image by restyling our website, social media and ADV. 

17 Development of tools (App and 3D video) to better understand and set up OMAL products according to specific needs. 

COMPLIANCE WITH SUSTAINABLE DEVELOPMENT GOALS

OMAL intends to continue its commitment to Sustainable Development Goals. For such reason, below are listed the methods that OMAL used, is currently using or will use to meet the need of integrating the 17 goals in its business approach, connecting in a synergetic way the company's operations with the creation of positive social-environmental impacts.



NO POVERTY

Promoting philanthropic projects in emergency situations, such as natural or other major disasters.



ZERO HUNGER

Promoting a responsible approach towards the food consumed in the company canteen, encouraging the supplier not to waste it.



GOOD HEALTH AND WELL-BEING

Ensuring to employees all the medical visits needed for their health in the workplace.



QUALITY EDUCATION

Partnership with local schools to teach how work is organized in a sustainability-oriented company and sponsorship of work-related learning programs, in order to participate in the training of young students.

Implementation of training programs within the company, aimed at the growth of the employees skills and the improvement of the work environment.



GENDER EQUALITY

Compliance and protection of gender diversity within the company.



CLEAN WATER AND SANITATION

Choice of distributing filtered tap water to avoid plastic waste.



AFFORDABLE AND CLEAN ENERGY

Using energy 100% from renewable sources. We have installed a photovoltaic plant and we use 93% of the energy produced, reducing the supply from the electricity grid. Quantification of the organization carbon footprint according to the ISO 14064 standard, monitoring its performances, and implementing CO₂eq reduction and/or offset actions.



DECENT WORK AND ECONOMIC GROWTH

Implementation and compliance with the Conflict Minerals Declaration for all our products. Implementation of training initiatives on safety and health in the workplace. Observance of the ban on any form of forced, compulsory and child labor, stating it in our Code of Ethics and requiring its compliance to our suppliers, by signing the Supplier Code of Conduct. Upholding the freedom of association and the effective recognition of the right to collective bargaining.



INDUSTRY, INNOVATION AND INFRASTRUCTURE

Investing in infrastructures with a low environmental impact for the Passirano production plant. Designing and manufacturing products that are more efficient both in terms of environmental impacts connected to their use and materials needed for their production.

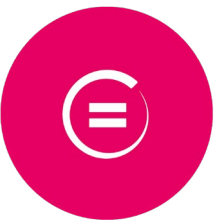

REDUCED INEQUALITIES

Protection and respect of staff diversity.
Compliance with the regulations on hiring vulnerable individuals.
Implementation and compliance with the non-Dual Use Declaration for our products.
Implementation and compliance with the Conflict Minerals Declaration for our products.



SUSTAINABLE CITIES AND COMMUNITIES

Implementation of the "Community Volunteering" project, for the benefit of local stakeholders. Organization of meetings with local schools to present a virtuous and responsible business model. Extension of the compliance with our Code of Ethics and Supplier Code of Conduct to all local suppliers, sharing values and principles of social-environmental Sustainability.



RESPONSIBLE CONSUMPTION AND PRODUCTION

Implementation and compliance with the Non-dual use Declaration, implementation and compliance with the Conflict Minerals Declaration for all our products. Promoting a Sustainable Business model, in compliance with the B Corp certification. Designing and manufacturing products that are more efficient both in terms of environmental impacts connected to their use and materials needed for their production, as well as their end-of-life and final disposal, by punctually updating our environmental policies.



CLIMATE ACTION

Investing in infrastructures with a low environmental impact for the Passirano production site. Designing and manufacturing products that are more efficient both in terms of environmental impacts connected to their use and materials needed for their production. Compliance with the European Regulation 1907/2006 REACH. Reducing, where possible, the food packaging of our suppliers. Quantification of the organization carbon footprint according to the ISO 14064 standard, monitoring its performance, and implementing CO₂eq reduction and/or offset actions.



LIFE BELOW WATER

Participating and promoting the 2019 B Corp National project to protect the seas from plastic waste.



LIFE ON LAND

Voluntarily performing extra checks on the radioactivity of inbound and in-process metals. We have participated to awareness initiatives in the sport sector on the subject of recovery and recycle of food surplus and waste, contributing to their collection on site.



PEACE, JUSTICE AND STRONG INSTITUTION

We have started the "AGCM Rating" certification process, aimed at the protection and valorization of transparency and ethicality principles in every business operation.



PARTNERSHIP FOR THE GOAL

Sharing our social-environmental projects with our stakeholders, especially with local associations and suppliers, in order to boost the growth of virtuous projects. Promotion of a Sustainable Business model collaborating with other B Corp companies.

COMPLIANCE WITH GLOBAL COMPACT PRINCIPLES

The company is committed to comply with Global Compact principles as an integrant part of its operations. In this list we link ten values to some OMAL projects, that, since the first year of membership in the Global Compact (2016), have distinguished its business model.

HUMAN RIGHTS

GC Goal 1: Businesses should support and respect the protection of internationally proclaimed human rights within their sphere of influence;

OMAL

- Protects and respects staff diversity
- Promotes philanthropic projects
- Implements and complies with the Conflict Minerals Declaration for all its products
- Respects and implements training activities on safety and health in the workplace,

GC Goal 2: make sure that they are not complicit in human rights abuses, even indirectly.

OMAL

- Implements and complies with the Conflict Minerals Declaration for all its products
- Implements and complies with the Non-dual use Declaration

LABOR

GC Goal 3: Businesses should uphold the freedom of association and the effective recognition of the right to collective bargaining;

GC Goal 4: the elimination of all forms of forced and compulsory labor;

GC Goal 5: the effective abolition of child labor;

GC Goal 6: the elimination of discrimination in respect of employment and occupation.

OMAL

- respects these principles as provided for by Italian and European laws regarding human and labor rights.
- reaffirms these principles in its Code of Ethics and asks its suppliers to respect them by accepting the Supplier Code of Conduct.

ENVIRONMENT

GC Goal 7: Businesses should support a precautionary approach to environmental challenges;

OMAL

- performs an extra check on the radioactivity of inbound and in-process metals
- carries on the Green IN program
- carries on the Green US program
- invests in infrastructures with a low environmental impact for the Passirano
- production site designs more efficient products with a lower environmental impact
- optimizes its production processes to reduce environmental impacts

GC Goal 8: undertake initiatives to promote greater environmental and social responsibility;

- has defined a supplier code of conduct and shared it with its suppliers, implements and complies with the Conflict Minerals Declaration for all its products;
- implements and complies with the Non-dual use Declaration;
- carries on the GREEN IN program;
- carries on the GREEN US program;
- quantifies the carbon footprint of its organization according to the ISO 14064 standard and monitors its performances, implementing CO₂eq reduction and/or offset actions;
- develops the “Community Volunteering” Project;
- has obtained the B Corp Certification and participates to the awareness activities organized by the B Corp network;
- organizes meeting with local schools to present a virtuous and responsible business model;

GC Goal 9: encourage the development and diffusion of environmentally friendly technologies.

- designs and manufactures products that are more efficient in terms of environmental impacts connected to energy consumption, use of materials, product end-of-life and its final disposal;
- complies with EU Regulation n. 1907/2006 REACH;
- carries on GREEN-IN program;
- carries on GREEN-US program.

ANTI-CORRUPTION

GC Goal 10: Businesses should work against corruption in all its forms, including extortion and bribery.

OMAL is committed to fight corruption in all its forms, reaffirming this principle in its Code of Ethics and asking its suppliers to undertake the same commitment.

OMAL has started the “AGCM Rating” certification process, aimed at the protection and valorization of transparency and ethicality principles in every business operation.

GLOSSARY

AA1000

Standard issued by AccountAbility that provides companies with tools to manage sustainability.

Environment

(extracted from ISO 14001)

Context in which an organization operates, including air, water, land, natural resources, plants, animals, people, and their interrelations.

Other GHG emission

Other GHG emissions, different from the GHG indirect emissions that are the result of energy consumption for the activities of an organization, but are the results of GHG sources owned or controlled by other organizations.

Carbon Footprint

Carbon Footprint (source: Ministry for the Environment and Protection of the Land and Sea). The carbon footprint is a measurement that expresses in CO₂ equivalent the total greenhouse gases directly or indirectly connected to a product, organization or service. In compliance with the Kyoto Protocol, the greenhouse gases to be included are:

carbon dioxide (CO₂), methane (CH₄), nitrous oxide (N₂O), hydro-fluorocarbons (HFCs), sulfur hexafluoride (SF₆) and per-fluorocarbons (PFCs). tCO₂e (tons of CO₂ equivalent) allows to express the greenhouse effect produced by these gases in relation to the greenhouse effect produced by CO₂, considered equal to 1 (e.g. methane has a greenhouse potential 25 times higher than CO₂, and therefore one ton of methane is counted as 25 tons of CO₂ equivalent).

Measuring the carbon footprint of a product or process requires, in particular, to identify and quantify the consumption of raw materials and energy in their different life-cycle stages.

CO₂ eq (carbon dioxide equivalent):

Parameter used to confront emissions of the different greenhouse gases according to the

global warming potential, expressed as Global Warming Potential (GWP). The value of CO₂ equivalent of a gas is obtained by multiplying its overall weight by the relative GWP.

Conflict minerals

Minerals extracted under conditions of armed conflict and human rights violation; that come from the Democratic Republic of the Congo and its neighboring States. Their use in the USA is regulated by the Dodd-Frank Act.

Direct energy consumption

Consumption connected to the use of primary energy sources (methane gas, fuel etc.) within areas owned or managed by the organization. An example is methane consumption for the functioning of thermal plants located within the organization sites.

Indirect energy consumption

Consumption connected to the use of primary energy sources (coal, methane gas, fossil fuels etc.) outside areas owned or managed by the organization. An example is the consumption of energy purchased from a Power Company, that uses primary energy sources to produce electricity in its sites.

GHG emission

Total mass of GHG released into the atmosphere in a specific period of time.

Direct emission of GHG

GHG emission from greenhouse sources owned or managed by the organization.

Indirect emission of GHG from energy consumption

GHG emission coming from the production of electricity, heat or steam imported and consumed by the organization.

FSC

Acronym of Forest Stewardship Council. This trademark identifies those products

containing wood from forests managed correctly and responsibly, according to rigorous environmental, social and economic standards. FSC is an international certification that allows an organization to ensure to the market the origin of wood and paper used for its products and therefore demonstrating in a correct, transparent and monitored way its active participation to a responsible forest management.

Greenhouse gases (GHG)

Gaseous constituents of the atmosphere, both natural and anthropogenic, that absorb and re-emit infrared radiations with specific wavelengths within the range of infrared radiation emitted by the earth surface, the atmosphere and the clouds. GHG gases include carbon dioxide (CO₂), methane (CH₄), nitrous oxide (N₂O), hydro-fluorocarbons (HFCs), sulfur hexafluoride (SF₆) and per-fluorocarbons (PFCs).

Green Procurement

Integration of environmental considerations into the procurement procedures of products and services, taking into account the environmental impacts during their life-cycles, from raw material extraction to waste disposal. Environmental impact (extracted from ISO 14001): Any modification of the environment, negative or positive, totally or partially caused by an organization's environmental aspects.

ISO 9001 is an International Standard that defines the requirements for a quality management system of an organization. This standard establishes guidelines to improve efficiency and effectiveness in manufacturing products or providing services, to increase the client satisfaction and loyalty.

Environmental Impact (extracted from ISO 14001)

Any modification of the environment, negative or positive, totally or partially caused by an organization's environmental aspects.

Industry 4.0

Industry 4.0 originates from the 4th industrial revolution, the process that will lead to a fully automated and interconnected production. New digital technologies will have a deep impact on four development paths: the first one concerns data use, computing power and connectivity, and is declined in big data, open data, Internet of Things, machine-to-machine and cloud computing for the centralization and storing of information. The second one concerns analytics: once the data are collected, it is necessary to extract their value. The third path is the interaction between man and machine, that involves "touch" interfaces, more and more common, and augmented reality. Lastly, there is the whole sector that focuses on the passage from digital to "real" and includes additive manufacturing, 3D printing, robotics, communications, machine-to-machine interactions and new technologies to store and use energy in a targeted way, rationalizing costs and optimizing performances.

Internet of Things

Internet of things includes a mix of technologies that allow to connect to the Internet any kind of equipment. The goal of this kind of solutions is basically to monitor, check and transfer information and subsequently implement consequent actions. The meaning of IoT is well expressed with examples: e.g. IoT is a fridge that orders milk when it "realizes" that is over. IoT is a house that turns the heat on as soon as you walk in. These are IoT examples, in other words objects that, connected to the internet, allow to join virtual and real world. The word IoT (Internet of Things) was introduced for the first time by Kevin Ashton, researcher at the MIT, Massachusetts Institute of Technology, where the RFID standard and other sensors were developed.

ISO 14001

International Standard that identifies the requirements for an «Environmental management system», that can identify

and assess the environmental aspects of an organization's activities, products and services, to continuously improve environmental performances and the requirements of the system itself. The standard can be used to obtain a third-party certification, as self-declaration or simply as a guideline to define, implement and improve an environmental management system.

ISO 14064

Voluntary standard published by the International Organization for Standardization (ISO), that defines the best international practices for managing, reporting and monitoring data and information on greenhouse gases (GHG).

ISO 9001

International Standard that defines the requirements for a quality management system of an organization. This standard establishes guidelines to improve efficiency and effectiveness in manufacturing products or providing services, to increase the client satisfaction and loyalty.

Employee

Individual who, according to National laws and practices, is recognized as an employee of the company that has drafted this report.

LCA (Life Cycle Assessment)

Analysis method that assesses a set of interactions that a product/component has with the environment, defining its direct or indirect impacts during its whole life-cycle: from its production to its recycle or final disposal.

Materiality

By materiality is meant the importance that a specific (economic, management, social or environmental) subject has for a company and its stakeholders (see stakeholder). Material are those aspects that reflect on economic, social and environmental impacts or substantially influence the considerations and decisions of

stakeholders.

Omnicality

Omni-channel is a multi-channel sales strategy that tries to guarantee a seamless shopping experience to clients, either they are purchasing online from a computer or mobile phone, or in a physical shop. The multi-channel approach assumes that there is an integration between distribution, promotion and communication channels in the back-end.

The omnicality strategy allows the client to carry on the purchasing process through different digital and physical channels, connected to offer an integrated and dynamic purchasing experience. In omnicality marketing the approach changes, with the client using simultaneously online and offline methods and the company integrating the strategic and organizational management channels in order to valorize the physical and interpersonal benefits of shops, to which a more motivated customer is attracted.

Environmental Policy (extracted from ISO 14001)

Intentions and general guidelines of a company in relation to its environmental performance as formally established by the general management. The environmental policy provides a reference framework for implementing activities and defining environmental goals and targets.

ReACH (Registration, evaluation, Authorisation and Restriction of Chemical substances):

European Community Regulation on chemicals and their safe use.

Stakeholder and multi-stakeholder

Stakeholders are groups or individuals that, reasonably, have interest or concern in an organization's activities, products and/or services. Stakeholders can affect or be affected

by the organization's actions, objectives and policies. According to the AA1000SES standard (developed by the British organization AccountAbility and recognized as a world-wide reference), an organization can prioritize its stakeholders or groups of stakeholders on the basis of their relevance. This is determined by a joint assessment of the dependence, influence and urgency that each stakeholder has towards the organization, or by other aspects that distinguish the relation between the stakeholder and the organization. The multi-stakeholder approach considers that a specific subject shall be addressed with the participation and collaboration of several actors who represent different interests and have different positions on that particular issue. These may include, for instance, different actors belonging to the production chain, representatives of institutions, other companies and non-profit organizations, etc.

Scope

It defines the operating boundaries in relation with GHG direct and indirect emissions.

Scope 1

It includes GHG direct emissions of an organization.

Scope 2

It includes GHG emissions originating from the production of energy, heat or steam imported and consumed by the organization.

Scope 3

It includes other indirect emissions different from those of Scope 2.

Sustainability and Sustainable Development

The most common definition of the concept of sustainable development is included in the "Brundtland Report" of the World Commission on Environment and Development (so called

after the name of the then president in office Gro Harlem Brundtland), developed in 1987. With sustainable development is meant a development model that "meets the needs of the present without compromising the ability of future generations to meet their own needs". Sustainability is therefore an approach (to the company as well as to its business activities) oriented to ensure a balance between present and future needs, by balancing economic, financial, social and environmental needs.

Supply Chain

Process of planning, implementing and monitoring the efficiency and effectiveness of the flow and storing of raw materials, semi-finished and finished products and their relative information from their origin to the consumer, in order to satisfy the client needs.

Well-to-wheel:

Analysis that includes the whole life-cycle of energy.



OMAL S.p.A.



Ph. +39 030 8900145 - Fax +39 030 8900143 - info@omal.it - www.omal.com

HEADQUARTERS

Via Ponte Nuovo, 11 - 25050 Rodengo Saiano (BS) ITALY

Coordinates:

Lat: 45° 35' 53" North; Lon: 10° 05' 21" East

PRODUCTION SITE

Via Brognolo, 12 - 25050 Passirano (BS) ITALY

Coordinates:

Lat: 45° 35' 51" North; Lon: 10° 05' 18" East